

# Arrakis MK3 Series

Version:  
v1.01

Date:  
12.12.2024



# Contents

<b>1</b>	<b>Copyright</b>	<b>3</b>
<b>2</b>	<b>Regulatory Compliances</b>	<b>4</b>
2.1	CE and UKCA Notice . . . . .	4
2.2	FCC PART 15 VERIFICATION STATEMENT . . . . .	5
2.3	ICES-003 ISSUE 7 VERIFICATION STATEMENT . . . . .	5
<b>3</b>	<b>Safety Instructions</b>	<b>6</b>
<b>4</b>	<b>Product Introduction</b>	<b>7</b>
4.1	About Arrakis MK3 . . . . .	7
4.2	Product Specifications . . . . .	7
<b>5</b>	<b>System Information</b>	<b>9</b>
5.1	System Drawing . . . . .	10
5.2	Mainboard Block Diagram . . . . .	12
<b>6</b>	<b>Mainboard Overview</b>	<b>13</b>
6.1	Mainboard Layout Overview . . . . .	13
6.2	Jumper Descriptions . . . . .	14
6.3	Jumper Settings Explained . . . . .	14
6.4	Detailed Jumper Settings . . . . .	14
<b>7</b>	<b>I/O Ports</b>	<b>17</b>
7.1	Connector Guide . . . . .	17
7.2	Connector Overview . . . . .	17
7.3	DC Power In . . . . .	18
7.4	CMOS Battery holder . . . . .	18
7.5	COM Ports . . . . .	19
7.6	LAN Ports . . . . .	20
7.7	USB Ports . . . . .	20
7.8	mPCIe MiniExpressCard . . . . .	20
<b>8</b>	<b>Interfaces and Connections</b>	<b>22</b>
8.1	Arrakis Mk3 Series . . . . .	23
<b>9</b>	<b>Radio Modules (only relevant with optional LTE/WiFi Modules)</b>	<b>24</b>
9.1	Radio Frequencies Sierra Wireless MC7455 . . . . .	24
9.2	Radio Frequencies Telit . . . . .	26
9.3	Radio Frequencies SparkLAN . . . . .	26
<b>10</b>	<b>BIOS</b>	<b>27</b>
10.1	Introduction . . . . .	27
10.2	Accessing BIOS . . . . .	27
10.3	BIOS Menu Overview . . . . .	28
10.4	BIOS Help Feature . . . . .	29
10.5	Detailed Menu Options . . . . .	30
10.6	Advanced BIOS Settings . . . . .	31
10.7	Security Settings . . . . .	37
10.8	Power Management . . . . .	38
10.9	Boot Configuration . . . . .	39

10.10 Exit Options . . . . .	40
<b>11 Driver Installation Guidance</b>	<b>41</b>
<b>12 Appendix A: Power Consumption</b>	<b>42</b>
<b>13 Appendix B: F75111N DIO &amp; Watchdog Device</b>	<b>43</b>
13.1 Watchdog Timer Usage in DOS . . . . .	43
13.2 Watchdog Timer and DIO Configuration . . . . .	44
13.3 IO Device: F75111 VB6 under Windows . . . . .	46
13.4 Watchdog Timer and DIO under Linux . . . . .	48

# 1 Copyright

## **Copyright and Trademarks, 2024 Publishing. All Rights Reserved**

This manual, software and firmware described in it are copyrighted by their respective owners and protected under the laws of the Universal Copyright Convention. You may not reproduce, transmit, transcribe, store in a retrieval system, or translate into any language, in any form or by any means, electronic, mechanical, magnetic, optical, chemical, biological, molecular, manual, or otherwise, any part of this publication without the express written permission of the publisher.

All products and trade names described within are mentioned for identification purpose only. No affiliation with or endorsement of the manufacturer is made or implied. Product names and brands appearing in this manual are registered trademarks of their respective companies. The information published herein has been checked for accuracy as of publishing time. No representation or warranties regarding the fitness of this document for any use are made or implied by the publisher.

We reserve the right to revise this document or make changes in the specifications of the product described therein at any time without notice and without obligation to notify any person of such revision or change.

## 2 Regulatory Compliances

### 2.1 CE and UKCA Notice

This device complies with the requirements of the CE directive and UKCA regulations.

**Low Voltage Directive 2014/35/EU + Electrical Equipment Safety Regulations 2016 (SI 2016 No 1101)**

- EN 62368-1 :2014+A11:2017

**EMC Directive 2014/30/EU + Electromagnetic Compatibility Regulations 2016**

- EN 50121-4:2016+A1:2019
- EN 61000-6-4:2007+A1:2011
- EN IEC 61000-3-3:2013+A1:2019
- EN 61000-3-3:2013+A1:2019
- EN 61000-4-2:2009
- EN 61000-4-3:2006+A1:2008+A2:2010
- EN 61000-4-4:2012
- EN 61000-4-5:2014+A1:2017
- EN 61000-4-6:2014+AC:2015
- EN 61000-4-8:2010
- BS EN 50121-4:2016+A1:2019
- BS EN 61000-6-4:2014
- BS EN IEC 61000-3-2:2013+A1:2019
- BS EN 61000-3-3:2013+A1:2019
- BS EN 61000-4-2:2009
- BS EN 61000-4-3:2006+A2:2010
- BS EN 61000-4-4:2012
- BS EN 61000-4-5:2014+A1:2017
- BS EN 61000-4-6:2014
- BS EN 61000-4-8:2010

**RoHS 2 Directive 2011/65/EU & 2015/863/EU + RoHS 2 Directive 2020 No. 1647**

RoHS 2 Directive 2011/65/EU & 2015/863/EU

Exemption(s) used:

6a, 6b, 6c



## 2.2 FCC PART 15 VERIFICATION STATEMENT

### WARNING

This equipment has been tested and found to comply with the limits for a Class A digital device, pursuant to part 15 of the FCC Rules. These limits are designed to provide reasonable protection against harmful interference when the equipment is operated in a commercial environment. This equipment generates, uses, and can radiate radio frequency energy and, if not installed and used in accordance with the instruction manual, may cause harmful interference to radio communications. Operation of this equipment in a residential area is likely to cause harmful interference in which case the user will be required to correct the interference at his own expense.

Notice: The changes or modifications not expressly approved by the party responsible for compliance could void the user's authority to operate the equipment.

This device complies with part 15 of the FCC Rules. Operation is subject to the following two conditions: (1) This device may not cause harmful interference, and (2) this device must accept any interference received, including interference that may cause undesired operation.

May contain transmitter module:

- N7NMC7455
- RYK-WPET236ACNBT

## 2.3 ICES-003 ISSUE 7 VERIFICATION STATEMENT

### CAN ICES3(A)/NMB3(A)

This device complies with CAN ICES-003 Issue 7 Class A. Operation is subject to the following two conditions: (1) This device may not cause harmful interference, and (2) this device must accept any interference received, including interference that may cause undesired operation. Cet appareil est conforme à la norme CAN ICES-003 Issue 7 Class A. Le fonctionnement est soumis aux deux conditions suivantes : (1) cet appareil ne doit pas causer d'interférences nuisibles et (2) cet appareil doit accepter toute interférence reçue, y compris les interférences pouvant opération indésirable.

May contain transmitter module:

- 2417C-MC7455
- 6158A-PET236ACNBT

# 3 Safety Instructions

Please read these instructions carefully and keep them for future reference.

## 1. Disconnect Before Cleaning

Unplug this equipment from the power outlet before cleaning. Do not use liquid or sprayed detergent. Use a moist cloth or sheet.

## 2. Avoid Humidity

Keep this equipment away from humidity.

## 3. Proper Power Cord Handling

Ensure the power cord is arranged to prevent people from stepping on it. Do not place anything over the power cord.

## 4. Follow Equipment Cautions

Note all cautions and warnings marked on the equipment.

## 5. Long Periods of Inactivity

If the equipment is unused for a long period, disconnect it from the main power to avoid damage from transient overvoltage.

## 6. Voltage Requirements

**Prolonged usage with less than 9V may damage the PSU or destroy the mainboard.**

## 7. Prevent Liquid Entry

Never pour any liquid into the openings of the equipment, as this could cause fire or electrical shock.

## 8. Service Personnel Assistance

If any of the following situations occur, have the equipment checked by qualified service personnel:

- The power cord or plug is damaged.
- Liquid has entered the equipment.
- The equipment has been exposed to moisture or condensation.
- The equipment is not functioning properly or fails to operate according to the user manual.
- The equipment has been dropped or physically damaged.

## 9. Storage Temperature

Do not leave this equipment in an unconditioned environment. Prolonged exposure to temperatures below -20°C or above 60°C may damage the equipment.

## 10. Unplug for Servicing

Unplug the power cord when performing any service or when adding optional kits.

## 11. Lithium Battery Caution

- Danger of explosion if the battery is replaced incorrectly. Replace only with the same or equivalent type recommended by the manufacturer. Dispose of used batteries according to the manufacturer's instructions.
- Do not remove the cover; there are no user-serviceable components inside. Take the unit to an authorized service center for service and repairs.

## 4 Product Introduction

### 4.1 About Arrakis MK3

Thank you for selecting the Welotec Arrakis MK3. The Arrakis MK3 is a robust, fanless embedded system designed for industrial computing applications. It utilizes industrial-grade components to ensure reliable operation in extreme and critical environments.

The Arrakis MK3 is equipped with a 1.6/2.0 GHz Quadcore Intel Atom® Processor E3950. The standard model includes a SoDIMM socket that supports 1866MHz DDR3L memory, enhancing its performance capabilities.

This system supports high-resolution display outputs through 1x HDMI and 1x Display Port, capable of handling resolutions up to 4K. It includes mSATA storage and one FullSize mPCIe socket. An optional expansion module can add 2x FullSize mPCIe sockets with USB and 2 external SIM sockets for enhanced connectivity. It also features four USB 3.0 ports, dual Gigabit-LAN, and customizable options such as CAN-Bus, Digital I/O, WLAN, and WWLAN, catering to various industrial needs. Additionally, it supports up to four COM ports.

The Arrakis MK3's versatile mounting options, including quick-setup wall mount and DIN mount, coupled with its durable aluminum housing and dust-proof design, make it an ideal choice for demanding industrial environments. This combination of durability, flexibility, and high-performance capabilities ensures that the Arrakis MK3 meets the needs of complex and critical industrial applications.

### 4.2 Product Specifications



## 4.2.1 Technical Details

Feature	Specification	Details
<b>Processor</b>	CPU	Intel Atom® Quadcore E3950, 1.6/2.0 GHz (Standard)
<b>Memory</b>	RAM	up to 8GB DDR3L SoDIMM
<b>Storage Options</b>	mSATA	1 mSATA 2.0 Slot
<b>Security</b>	TPM	TPM 2.0 with TrEE 1.1
<b>I/O Ports</b>	HDMI	1 HDMI port
	DisplayPort	1 DisplayPort
	Gigabit Ethernet	2x RJ45 ports
	USB 3.0	4 ports
	Serial Ports	2x RS232/RS485, optional expansion for 2 additional
	Digital I/O	1 DI, 12-24V 1 DO, 12-24V, max. 2 A, output voltage defined by DC input
	<b>Connectivity</b>	Ethernet
	WLAN (optional)	Optional, via mPCIe
	WWAN (optional)	Optional 4G/5G via USB
<b>Expansion</b>	SIM Slots	2 push-push type SIM slots (available with 4G/5G modules)
<b>Additional</b>	Audio and Other	Line in/out, Digital I/O, CAN (optional)
	Watchdog Timer	Programmable from 1 to 255 seconds
<b>Environmental</b>	Operating Temperature	-20° to 70° C
	Storage Temperature	-20° to 80° C
	Humidity	5% to 95% non-condensing
<b>Power</b>	Supply	9 - 36 V DC (+/-10% tolerance), 4-pin terminal block and DC jack
	Adapter	Optional 60W, 24V/5A external, CR1220 CMOS battery
<b>Mounting</b>	Options	DIN-Rail mounting kits available
<b>Operating System</b>	Compatibility	Windows 10, Ubuntu Linux, others upon request
<b>Physical Build</b>	Material/Color	Steel / Aluminum
	Ingress Protection	IP20
	Dimensions	64 x 140 x 92 mm
	Weight	800 g

## 5 System Information



Being a powerful, yet small fanless system, the Arrakis Pico Mk4 may reach very high surface temperatures in excess of 60°C/140°F with risk of injury. Users should ensure sufficient protection against touching.

To allow for sufficient heat removal we recommend: 30mm distance on either side of the Arrakis Pico Mk4 when mounted on a DIN-Rail 100mm headroom above the Arrakis Pico Mk4 when mounted horizontally. The heatsink should be on top.

## 5.1 System Drawing

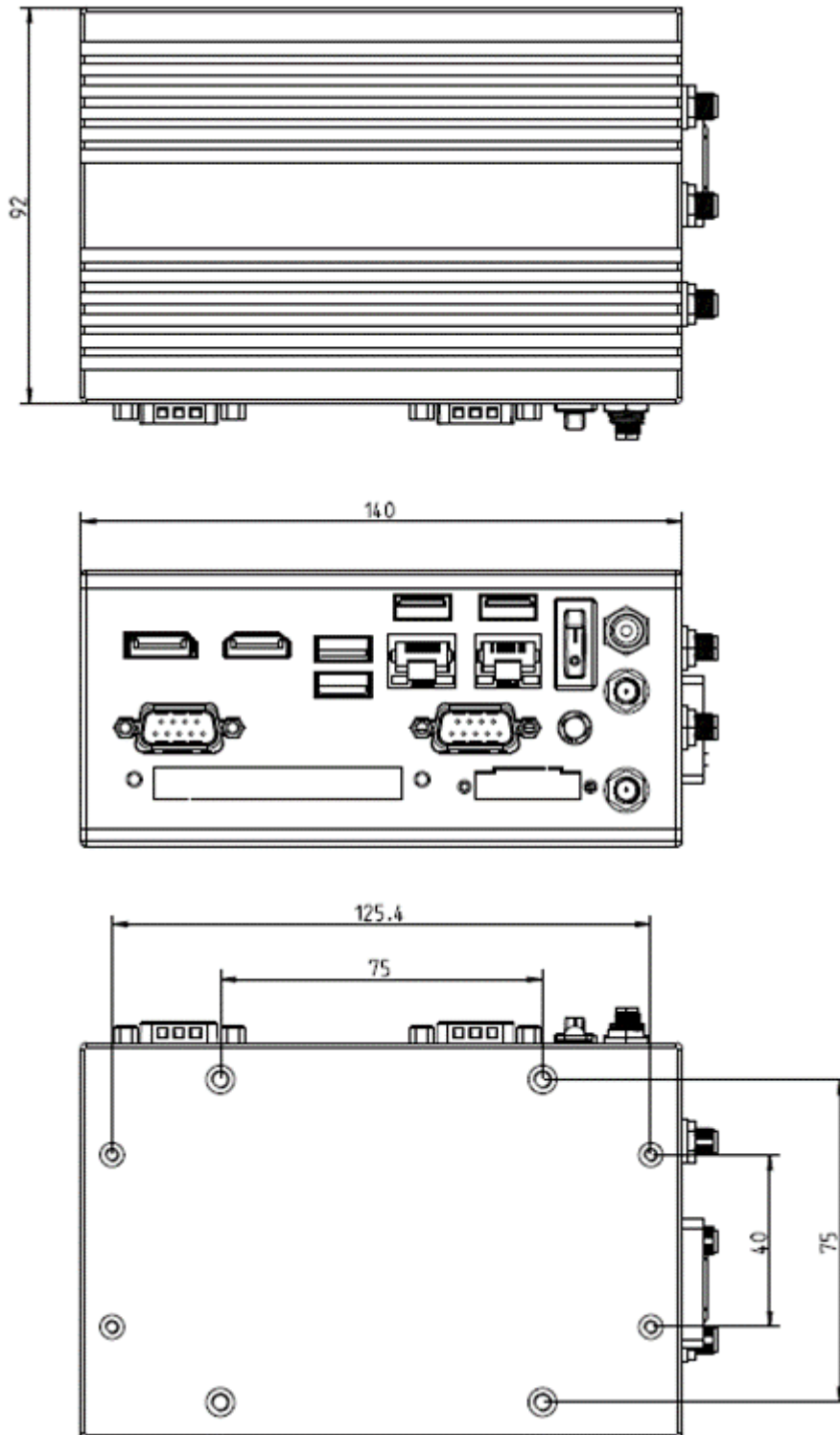

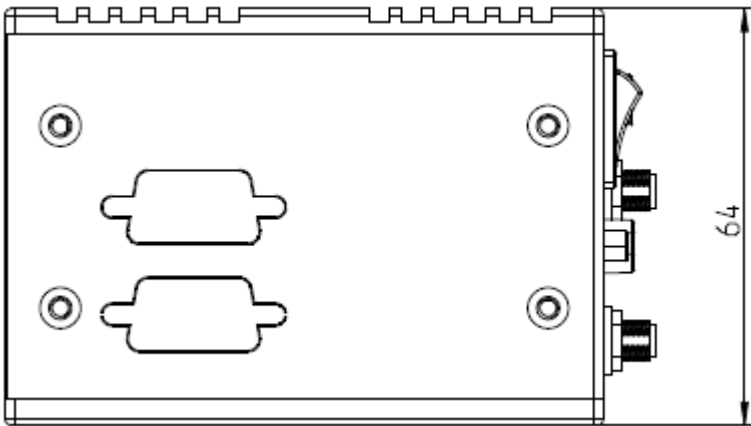

Bottom side

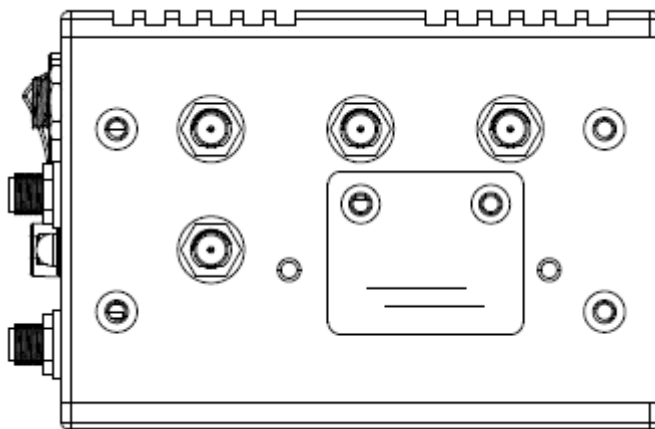

Top side

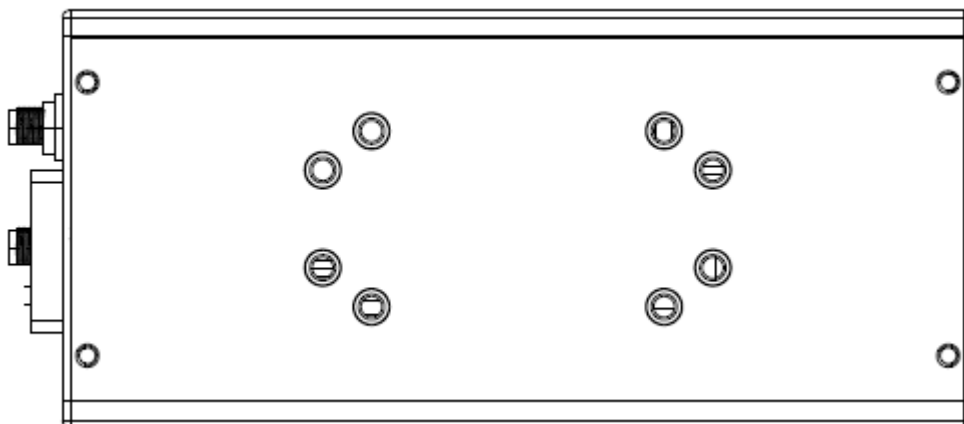

Rear side

## 5.2 Mainboard Block Diagram

This block diagram describes the relationship among all interfaces and modules on the mainboard.

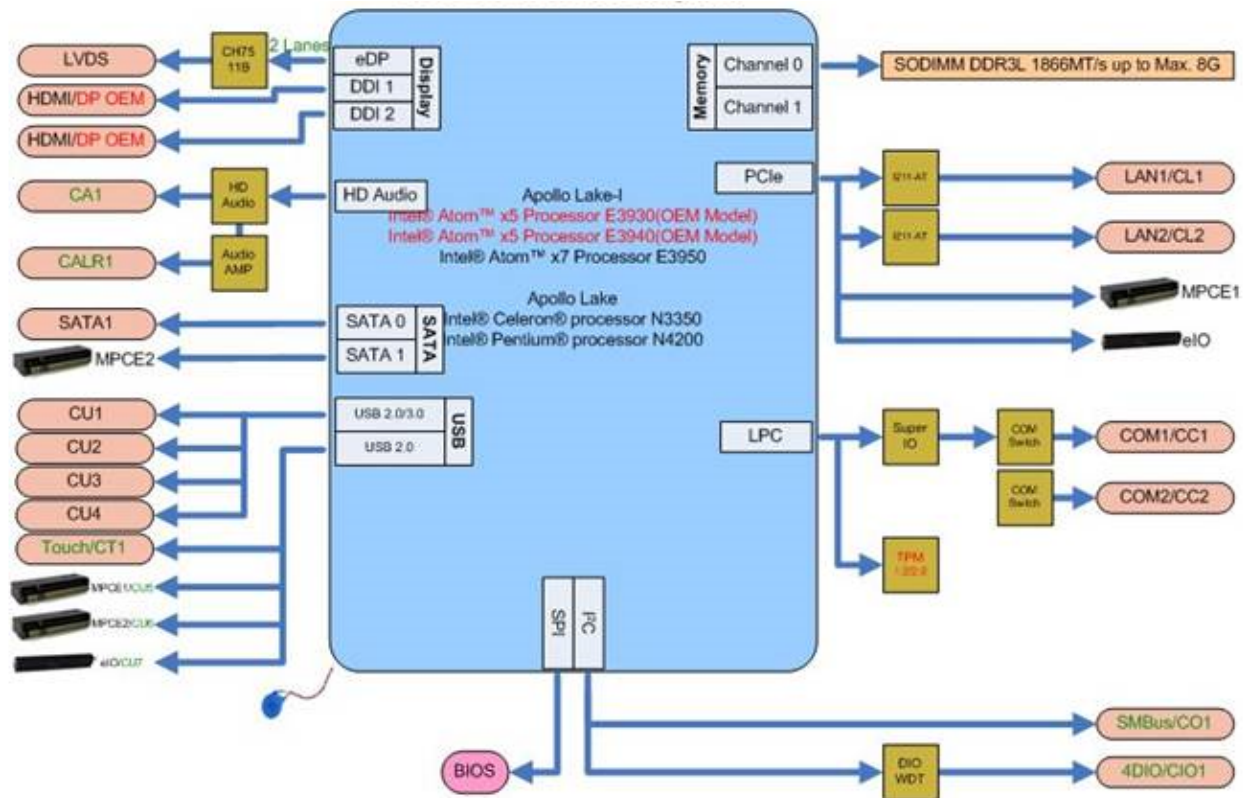

# 6 Mainboard Overview

## 6.1 Mainboard Layout Overview

View the detailed layout to understand the location of connectors on the mainboard:

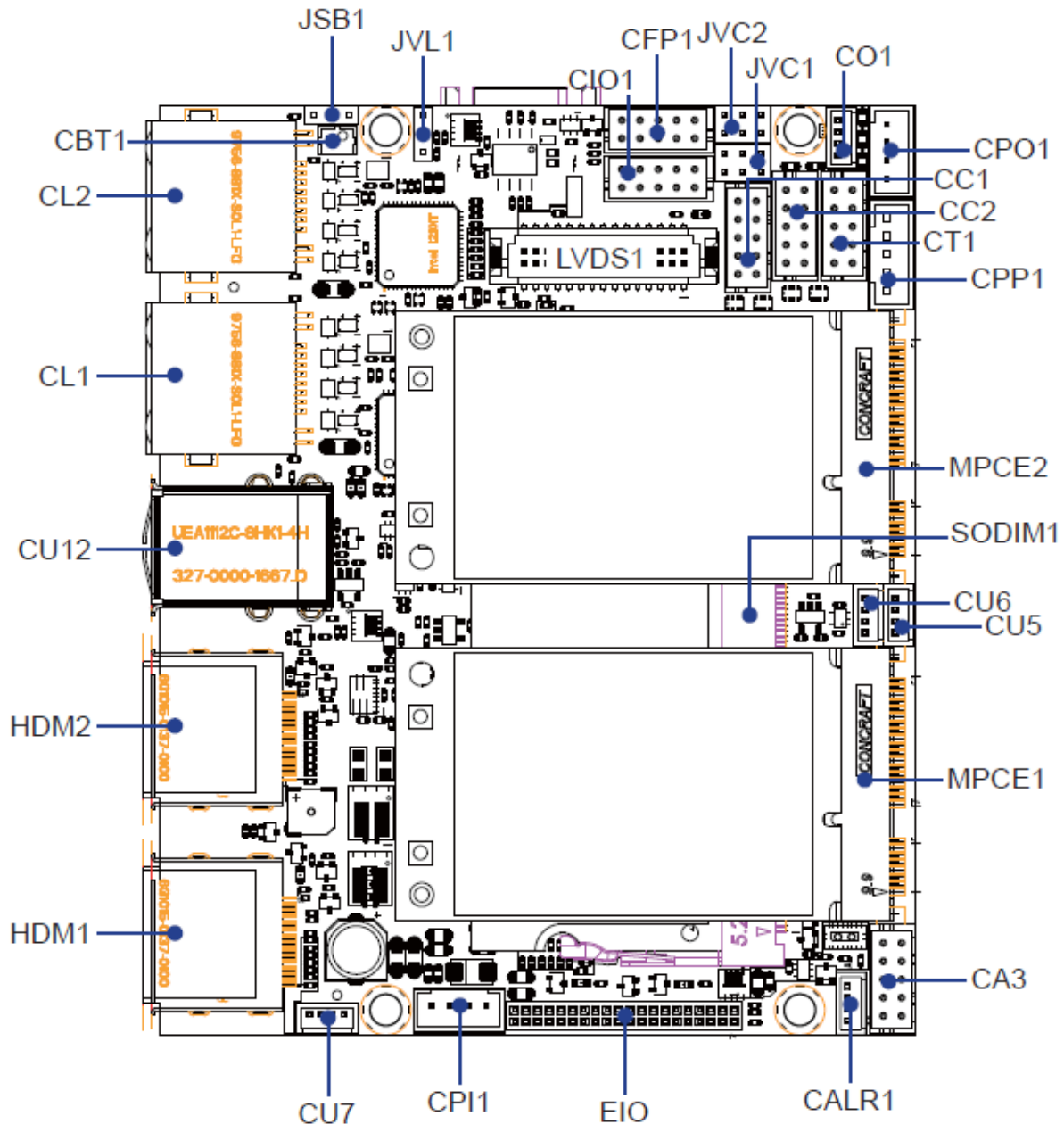

## 6.2 Jumper Descriptions

### Jumper Configurations:

- **JSB1:** Clears CMOS data
- **JVL1:** Selects power for the LCD panel
- **JVC1/JVC2:** Configures COM1/2 ring indicator and power selection

## 6.3 Jumper Settings Explained

Jumpers manage electrical connections on a mainboard. A jumper is set to “ON” when a plastic cap bridges two pins, creating a closed circuit. It is set to “OFF” when the cap is removed, opening the circuit. Some jumpers include three pins (1, 2, and 3), allowing configurations between pins 1-2 or 2-3. The illustration below demonstrates

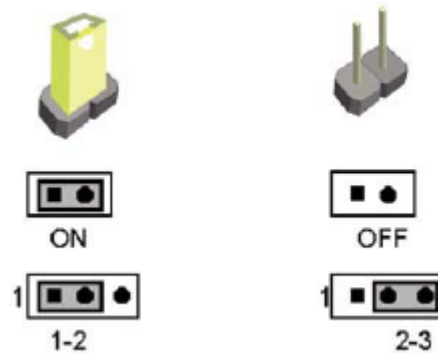

various jumper settings:

All jumpers are preset to their default configurations, marked with an asterisk (\*) in this guide, either as ON (with cap) or OFF (without cap).

## 6.4 Detailed Jumper Settings

### 6.4.1 JSB1: CMOS Data Reset

To maintain or clear the motherboard’s CMOS settings:

1. Power off the system and disconnect all power sources.
2. Disconnect the 12V DC power cable.
3. Set JSB1 jumper between pins 1 and 2 to clear CMOS.
4. Reset JSB1 to its default setting (typically pin 1-2 closed).
5. Reconnect the 12V DC power cable.

This procedure is typically used for troubleshooting or if the BIOS password is forgotten.

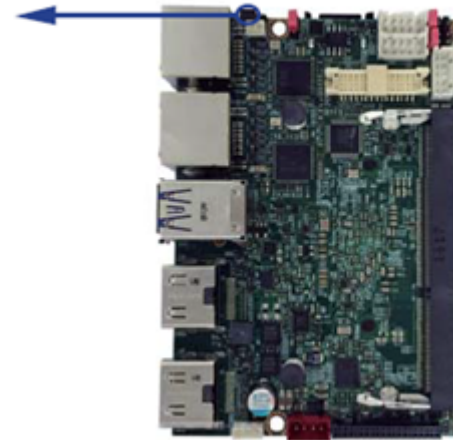
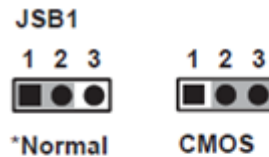

JSB1	Description
*1-2	Normal set
2-3	CMOS data clear

JSB1 Illustrations:

## 6.4.2 JVL1: LCD Panel Power Selection

Adjust JVL1 to select the appropriate power setting for your LCD panel.

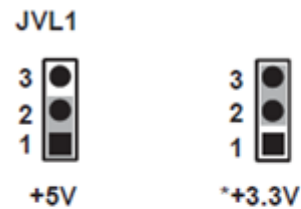

JVL1	Description
1-2	+5V
*2-3	+3.3V

JVL1 Settings Visualization:

## 6.4.3 JVC1/JVC2: COM Port Configuration

Set JVC1 and JVC2 to configure power and signal settings for COM1 and COM2 ports.



JVC1/JVC2	DESCRIPTION
*1-2	RI
3-4	+5V
5-6	+12V



**JVC2**

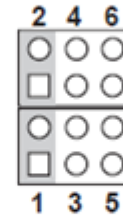

**JVC1**

\*RI Signal



+5V



+12V

JVC1/JVC2 Configuration:

# 7 I/O Ports

## 7.1 Connector Guide

This section provides a comprehensive overview of all connectors, switches, and indicators necessary for peripheral setup. Before installation, ensure the system is powered off and disconnected from any power sources.

## 7.2 Connector Overview

- **BAT1:** Holds a 3V lithium battery.
- **CA3:** Facilitates connections for Line-out, Line-in, Mic-in, and SPDIF-out via a 2x5 pin (2.0mm) wafer.
- **CALR1:** Connects right/left audio channels through a 4-pin (1.25mm) wafer for amplifier outputs.
- **CC1 & CC2:** Serial communication ports; CC1 features a DB9 connector, while CC2 utilizes a 2x5 pin (2.0mm) wafer.
- **CBT1:** 2-pin (1.25mm) wafer battery holder for a 3V lithium battery.
- **CFP1:** Front Panel control connector with a 2x5 pin (2.0mm) wafer.
- **CIO1:** Digital I/O connector via a 2x5 pin (2.0mm) wafer.
- **CL1 & CL2:** Network ports with RJ45 connectors for LAN connections.
- **CO1:** I2C bus connection via a 1x4 pin (1.25mm) wafer.
- **CPI1 & CPO1:** Power input and output connectors, respectively, with 4-pin (2.0mm) wafer configurations.
- **CU3, CU4, CU12, CU5, CU6, CU7:** Various USB ports for device connectivity and data transfer.
- **LVDS1:** Low-Voltage Differential Signaling connector, via a 2x15 pin (1.25mm).
- **CPP1 & CT1:** Connectors for backlight power and touch interface, respectively.
- **SATA1:** Provides connectivity for SATA storage devices.
- **MPCE1 & MPCE2:** Full-size Mini PCIe sockets for expanding functionalities.
- **HDMI1 & HDMI2:** Video output connectors for HDMI and Display Port.
- **EIO1:** Extended input/output port via a 2x20 pin (1.27mm) wafer.

### 7.2.1 Safety and Handling

- **Safety:** Always ensure the system is completely powered off and disconnected from any power source before connecting or disconnecting peripherals.
- **Handling:** Carefully handle connectors and avoid forceful insertion to prevent damage to pins and ports.

## 7.3 DC Power In



Pin	Description
0 (left)	9 – 36V+
1,2 (middle)	External Power Switch
3 (right)	Ground

## 7.4 CMOS Battery holder

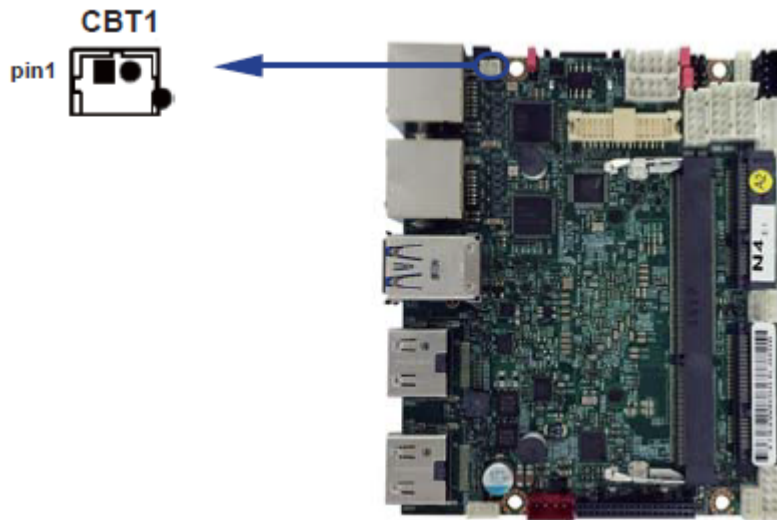

PIN NO.	DESCRIPTION
1	GND
2	+3V

### CBT1: 3V Battery Holder Specifications

- **Connector:** CBT1 is a 2-pin holder for a 3V Lithium battery.
- **Battery Specifications:** Uses a CR1220 Lithium battery, 3V/40mAh.

### Note on Power Consumption:

- Without a connected power adapter: approximately 2.7 microamperes (uA).
- With a connected power adapter: approximately 0.1 microamperes (uA).

## 7.5 COM Ports

RS232 mode:

PIN NO.	Description	PIN NO.	Description
1	DCD	6	DSR
2	RXD	7	RTS
3	TXD	8	CTS
4	DTR	9	RI/Voltage
5	GND		

RS422 mode:

PIN NO.	Description	PIN NO.	Description
1	RS422 TX-	6	NC
2	RS422 TX+	7	NC
3	RS422 RX+	8	NC
4	RS422 RX-	9	NC
5	GND		

RS485 mode:

PIN NO.	Description	PIN NO.	Description
1	RS485 TX-	6	NC
2	RS485 TX+	7	NC
3	NC	8	NC
4	NC	9	NC
5	GND		

## 7.6 LAN Ports

PIN NO.	Description	PIN NO.	Description
1	TR0-/TX+	5	TR2-/NC
2	TR0+/TX-	6	TR2+/RX-
3	TR1-/RX+	7	TR3-/NC
4	TR1+/NC	8	TR3+/NC

## 7.7 USB Ports

PIN NO.	Description
1	+5V
2	DATA -
3	DATA +
4	GND

## 7.8 mPCIe MiniExpressCard

The Arrakis MK3 is equipped with four mPCIe connectors, enhancing its flexibility and connectivity options:

### 1. Full-size mPCIe Slots:

- **Primary Slot:** Typically preoccupied with an mSATA SSD, which is not readily available for other uses.
- **Secondary Slot:** Facilitates connections for USB, mSATA, and PCIe interfaces, offering versatile usage.

### 2. Additional Full-size mPCIe Slots:

- These slots are configurable based on specific requirements, available either on demand or with a pre-installed 4G modem. Generally, one of these is dedicated to the 4G modem, limiting the other for USB device compatibility.

PIN NO.	Description	PIN NO.	Description
1	NC	2	+3.3V
3	NC	4	GND
5	NC	6	+1.5V
7	NC	8	NC
9	GND	10	NC
11	PCIe-CLK-	12	NC
13	PCIe-CLK+	14	NC
15	GND	16	NC
KEY			
17	NC	18	GND
19	NC	20	NC
21	GND	22	Reset
23	PCIe-RX-/mSATA-RX+	24	+3.3V
25	PCIe-RX+/mSATA-RX-	26	GND
27	GND	28	+1.5V
29	GND	30	SMB-CLK
31	PCIe-TX-/mSATA-TX-	32	SMB-DATA
33	PCIe-TX+/mSATA-TX+	34	GND
35	GND	36	USB-DATA-
37	GND	38	USB-DATA+
39	+3.3V	40	GND
41	+3.3V	42	NC
43	GND	44	NC
45	NC	46	NC
47	NC	48	+1.5V
49	NC	50	GND
51	mSATA/PCIe detect	52	+3.3V

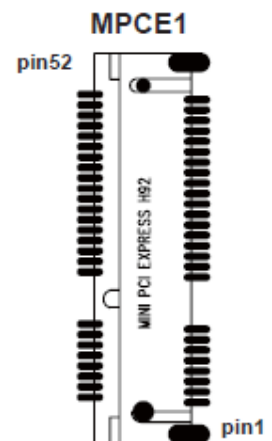
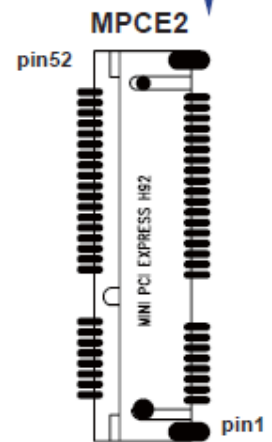
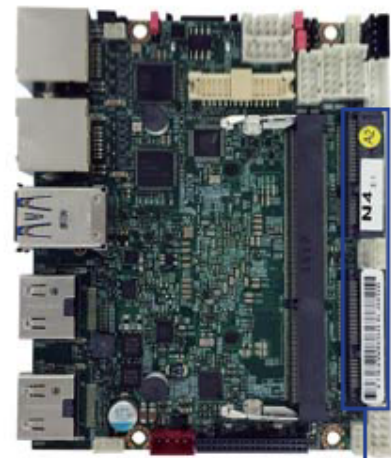

# 8 Interfaces and Connections





# 9 Radio Modules (only relevant with optional LTE/WiFi Modules)

The Arrakis Mk3 may contain the following RF Modules:

- Sierra Wireless MC7455
- Telit Cinterion LEPCIC4EU08T080700
- SparkLAN WZ-WPET-236ACN(BT)

**LTE:**

Sierra Wireless MC7455	Supported Bands
LTE	B1/ B2/ B3/ B4/ B5/ B7/B8/ B12/B13/ B20/ B25/ B26/B29/B30/ B41
WCDMA	B1/ B2/ B3/ B4/ B5/ B8

**WiFi**

SparkLAN WZ-WPET-236ACN(BT)	
Operating Frequency	IEEE 802.11ac/a/b/g/n/ISM Band: 2.412GHz~2.484GHz, 5.150GHz~5.850GHz*Subject to local regulations

## 9.1 Radio Frequencies Sierra Wireless MC7455

## 9.1.1 4G LTE Europe

Band	Frequency Range Down	Frequency Range Up	Max Transmission Power
Band 1	2110 MHz - 2170 MHz	1920 MHz - 1980 MHz	199 mW
Band 2	1930 MHz - 1990 MHz	1850 MHz - 1910 MHz	199 mW
Band 3	1805 MHz - 1880 MHz	1710 MHz - 1785 MHz	199 mW
Band 4	2110 MHz - 2155 MHz	1710 MHz - 1755 MHz	199 mW
Band 5	869 MHz - 894 MHz	824 MHz - 849 MHz	199 mW
Band 7	2620 MHz - 2690 MHz	2500 MHz - 2570 MHz	199 mW
Band 8	925 MHz - 960 MHz	880 MHz - 915 MHz	199 mW
Band 12	729 MHz - 746 MHz	699 MHz - 716 MHz	199 mW
Band 13	746 MHz - 756 MHz	777 MHz - 787 MHz	199 mW
Band 20	791 MHz - 821 MHz	832 MHz - 862 MHz	199 mW
Band 25	1930 MHz - 1995 MHz	1850 MHz - 1915 MHz	199 mW
Band 26	859 MHz - 894 MHz	814 MHz - 849 MHz	199 mW
Band 28	758 MHz - 803 MHz	703 MHz - 748 MHz	199 mW
Band 29	717 MHz - 728 MHz	n/a	199 mW
Band 30	2350 MHz - 2360 MHz	2305 MHz - 2315 MHz	199 mW
Band 41	2496 MHz - 2690 MHz	2496 MHz - 2690 MHz	199 mW

## 9.1.2 3G WCDMA

Band	Frequency Range Down	Frequency Range Up	Max Transmission Power
Band 1	2110 MHz - 2170 MHz	1920 MHz - 1980 MHz	251 mW
Band 2	1930 MHz - 1990 MHz	1850 MHz - 1910 MHz	251 mW
Band 3	1805 MHz - 1880 MHz	1710 MHz - 1785 MHz	251 mW
Band 4	2110 MHz - 2155 MHz	1710 MHz - 1755 MHz	251 mW
Band 5	869 MHz - 894 MHz	824 MHz - 849 MHz	251 mW
Band 8	925 MHz - 960 MHz	880 MHz - 915 MHz	251 mW

## 9.1.3 3G UMTS

Band	Frequency Range Down	Frequency Range Up	Max Transmission Power
Band 1	2110 MHz - 2170 MHz	1920 MHz - 1980 MHz	251 mW
Band 2	1930 MHz - 1990 MHz	1850 MHz - 1910 MHz	251 mW
Band 3	1805 MHz - 1880 MHz	1710 MHz - 1785 MHz	251 mW
Band 4	2110 MHz - 2155 MHz	1710 MHz - 1755 MHz	251 mW
Band 5	869 MHz - 894 MHz	824 MHz - 849 MHz	251 mW
Band 8	925 MHz - 960 MHz	880 MHz - 915 MHz	251 mW

## 9.2 Radio Frequencies Telit

Band	Frequency Range Down	Frequency Range Up	Max Transmission Power
Band 1	2110 MHz - 2170 MHz	1920 MHz - 1980 MHz	199 mW
Band 3	1805 MHz - 1880 MHz	1710 MHz - 1785 MHz	199 mW
Band 7	2620 MHz - 2690 MHz	2500 MHz - 2570 MHz	199 mW
Band 8	925 MHz - 960 MHz	880 MHz - 915 MHz	199 mW
Band 20	791 MHz - 821 MHz	832 MHz - 862 MHz	199 mW
Band 28A	758 MHz - 803 MHz	703 MHz - 748 MHz	199 mW

## 9.3 Radio Frequencies SparkLAN

### 9.3.1 WiFi Output Power & Sensitivity

IEEE Standard	Data Rate	Tx ± 2dBm	Rx Sensitivity
802.11b	11Mbps	18dBm	⌀-85dBm
802.11g	54Mbps	14.5dBm	⌀-71dBm
802.11n / 2.4GHz (HT20)	MCS7	14dBm (1TX)17dBm (2TX)	⌀-67dBm
802.11n / 2.4GHz (HT40)	MCS7	13.5dBm (1TX)16.5dBm (2TX)	⌀-65dBm
802.11a	54Mbps	14dBm	⌀-75dBm
802.11n / 5GHz (HT20)	MCS7	13dBm (1TX)16dBm (2TX)	⌀-71dBm
802.11n / 5GHz (HT40)	MCS7	13dBm (1TX)16dBm (2TX)	⌀-67dBm
802.11ac (VHT80)	MCS9	11dBm (1TX)14dBm (2TX)	⌀-57dBm
Bluetooth	3Mbps	0 ⌀Output Power ⌀4 dBm	

### Notes

- **Down:** Refers to the downlink frequency range.
- **Up:** Refers to the uplink frequency range.
- **Max Transmission Power:** Maximum power at which the device transmits.

# 10 BIOS

## 10.1 Introduction

The BIOS (Basic Input/Output System) serves as the fundamental bridge connecting the motherboard and operating system in your computer. It resides in the Flash Memory on the motherboard. When you start up the computer, the BIOS is the first to take control, initiating a series of checks known as the POST (Power-On Self Test) to ensure all hardware components are functioning properly. It identifies and configures hardware settings and prepares the system to hand over control to the operating system. The BIOS is crucial for system stability and optimal performance.

Within the BIOS setup menu, you'll find a range of options to configure. Below, we outline the function keys used to navigate and modify settings within the BIOS:

- **Esc:** Exit the BIOS setup.
- **Arrow keys (↑↓←→):** Navigate through options.
- **F10:** Save changes and exit.
- **Page Up/Page Down or +/-:** Adjust settings for selected options.

## 10.2 Accessing BIOS

To enter the BIOS setup:

1. Power on your computer and immediately press the **Del** key.
2. If you miss the initial prompt, restart your system by turning it off and on, or by pressing **Ctrl, Alt, and Delete** simultaneously to perform a soft reboot.

## 10.3 BIOS Menu Overview

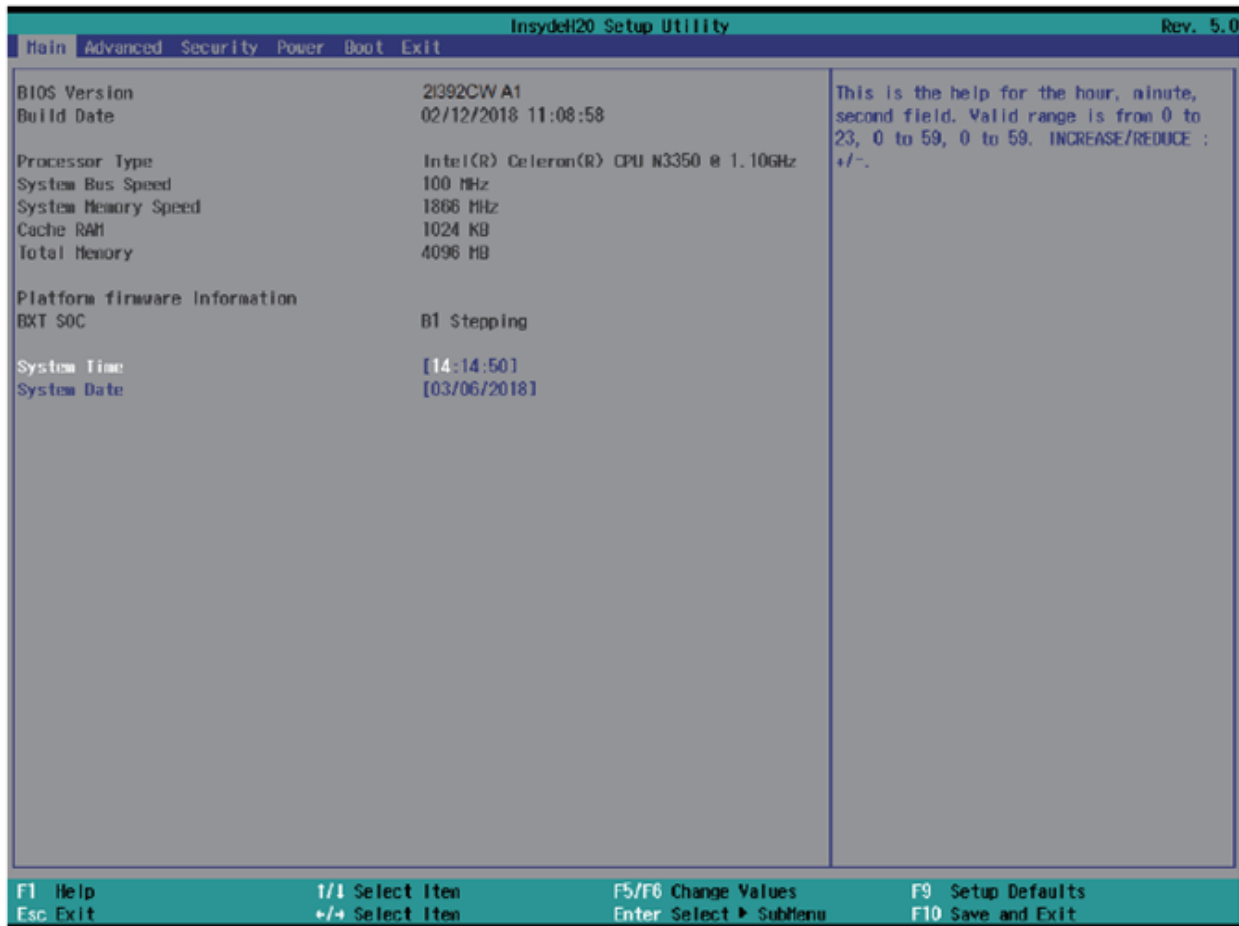

The BIOS main menu offers a range of configurable settings crucial for tailoring your system's operation. Here's how you can navigate through these options efficiently:

- **Navigating Screens:** Use the left (←) and right (→) arrow keys to switch between different settings screens.
- **Selecting Options:** Use the up (↑) and down (↓) arrow keys to highlight the specific option you want to adjust or confirm in the main menu.
- **Modifying Values:** Press **Enter** to select an option for modification. Use the plus (+) and minus (-) keys to adjust the values for the selected option.
- **Shortcut Keys:**
  - **F1:** Displays general help.
  - **F2:** Reverts to the previous value.
  - **F3:** Loads optimized default settings.
  - **F4:** Saves changes and resets the system.
  - **Esc:** Exits the BIOS Setup.

### 10.3.1 Menu Tabs:

- **Main:** Adjust basic system settings.
- **Advanced:** Modify advanced system configurations.
- **Security:** Set or change BIOS passwords.
- **Power:** Manage ACPI settings and power management options.
- **Boot:** Configure system boot options.
- **Exit:** Save changes or load default settings before exiting.

The selected tab is highlighted for easier navigation.

## 10.4 BIOS Help Feature

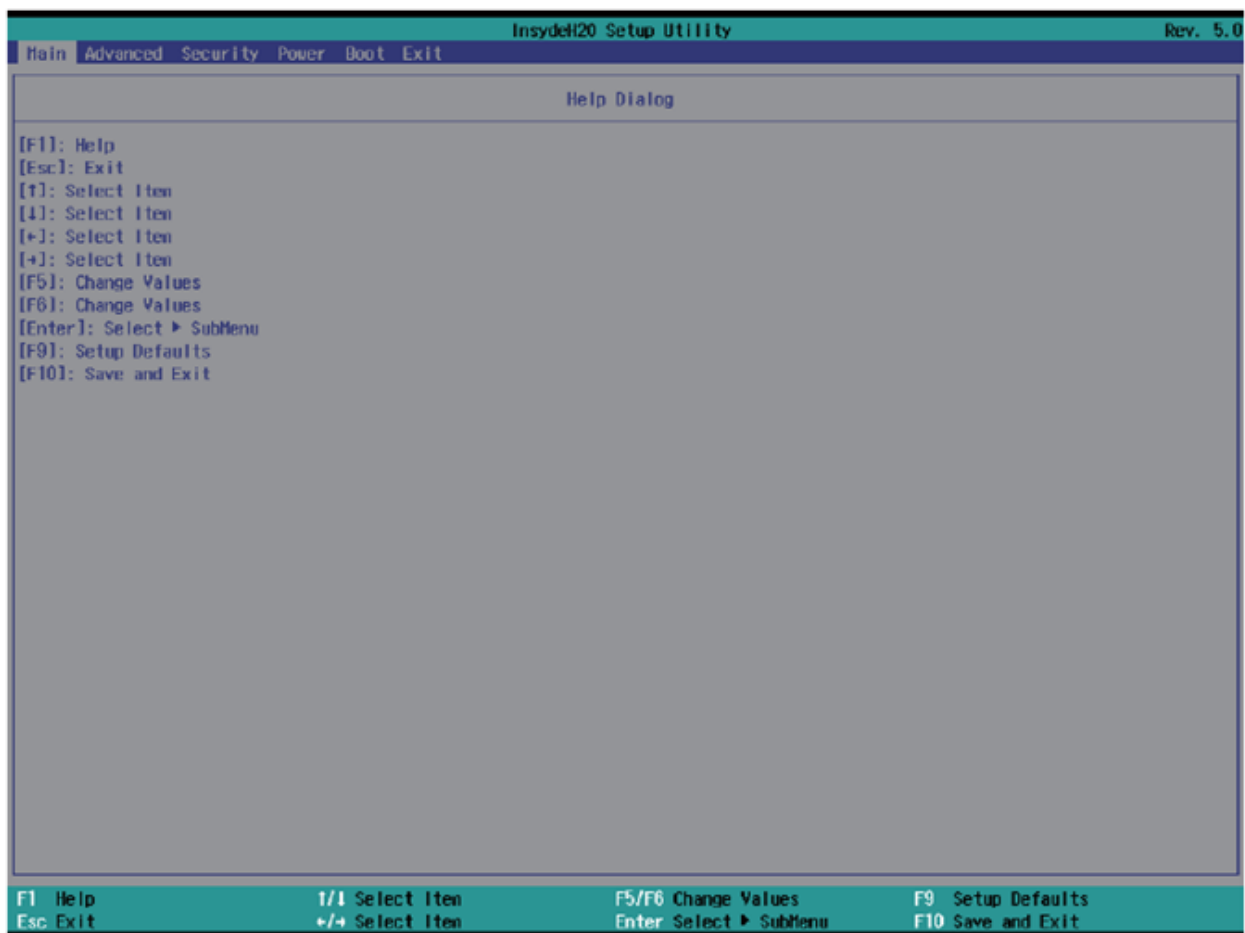

Access the BIOS Help window by pressing F1. This feature provides a detailed description of the function keys and their uses for the highlighted menu item. Press Esc to close the Help window.

## 10.5 Detailed Menu Options

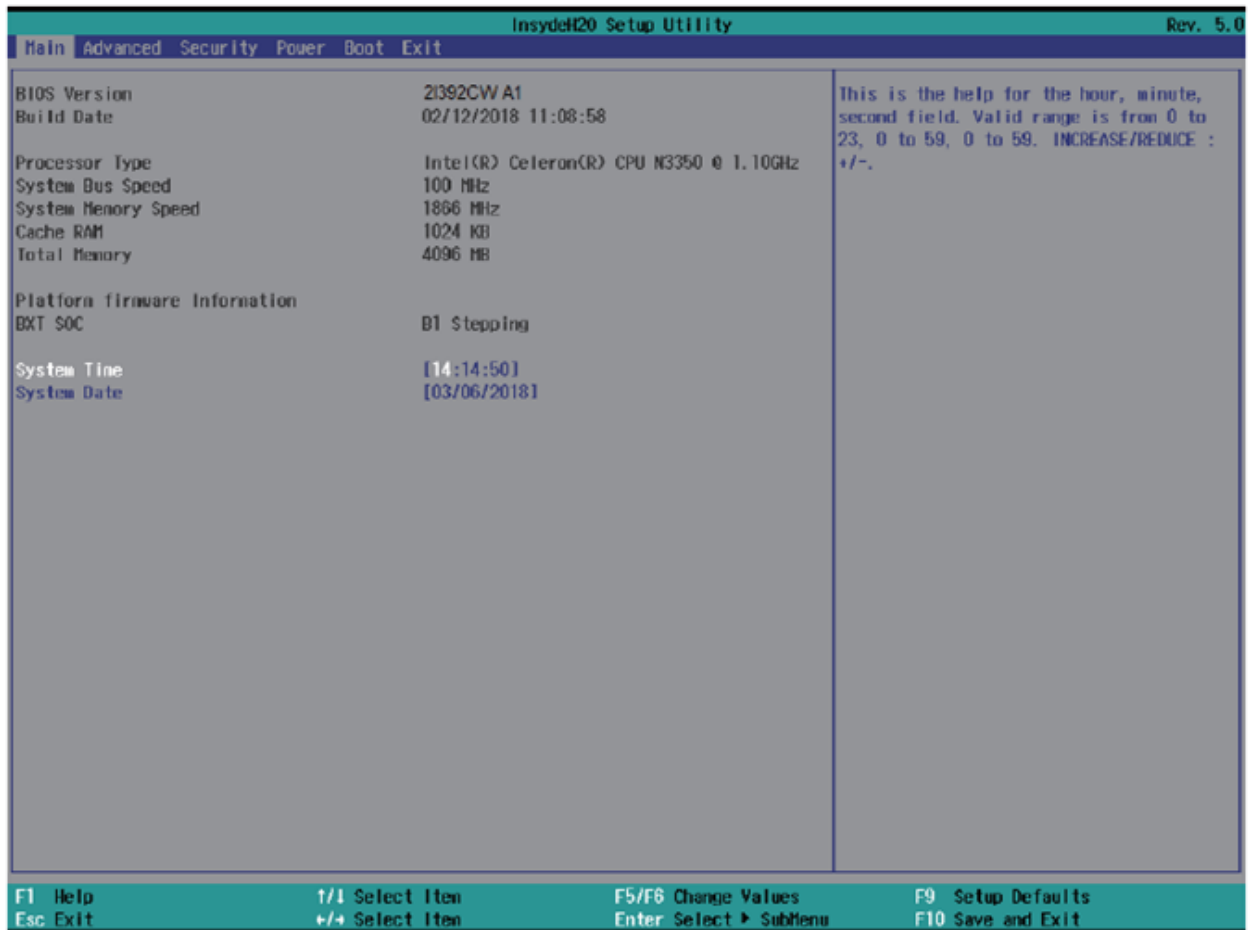

The main menu screen displays basic system information and allows for easy configuration:

- **System Date:** Adjust the system date by using the Tab key to move between elements and the numerical keys to set the values.
- **System Time:** Set the system time in a similar manner, utilizing the Tab key for navigation and numerical keys for adjustments.

These settings help ensure that your system functions correctly and maintains accurate logs of system events and tasks.

## 10.6 Advanced BIOS Settings

Explore the configuration possibilities for your system's performance and functionality. Adjust settings to suit your hardware requirements and preferences.

### 10.6.1 Video Configuration

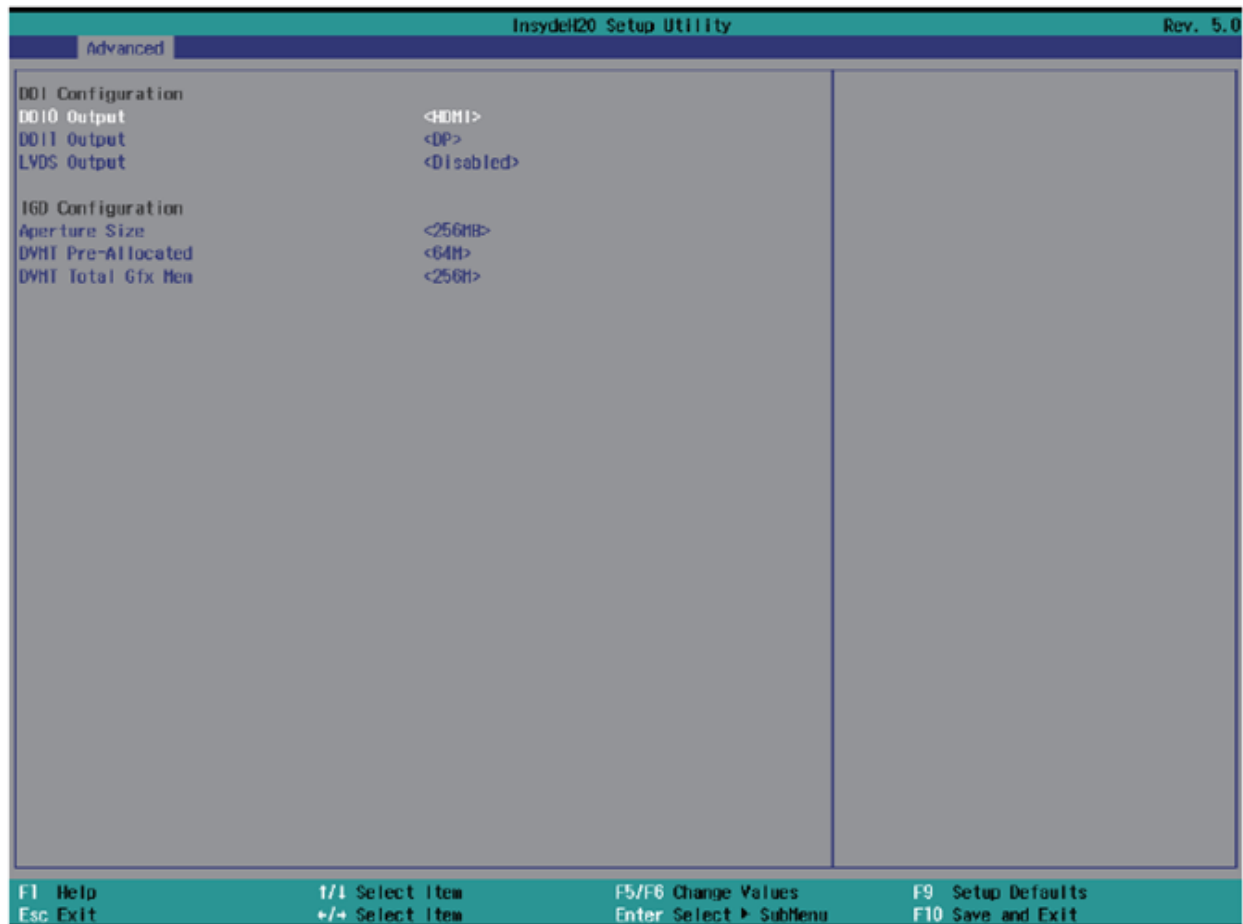

Fine-tune the graphics performance by configuring the memory allocation:

- **Aperture Size:** Choose between 128MB, 256MB (default), or 512MB to optimize your system's graphics memory usage.
- **IGD - DVMT Pre-Allocated:** Set the fixed allocation for the integrated graphics memory. Available options are 64MB (default), 128MB, 256MB, or 512MB to enhance video performance.
- **IGD - DVMT Total Gfx Mem:** Adjust the total available graphics memory for the system, with choices of 128MB, 256MB (default), or the maximum supported by your hardware.



## 10.6.2 HD-Audio Configuration

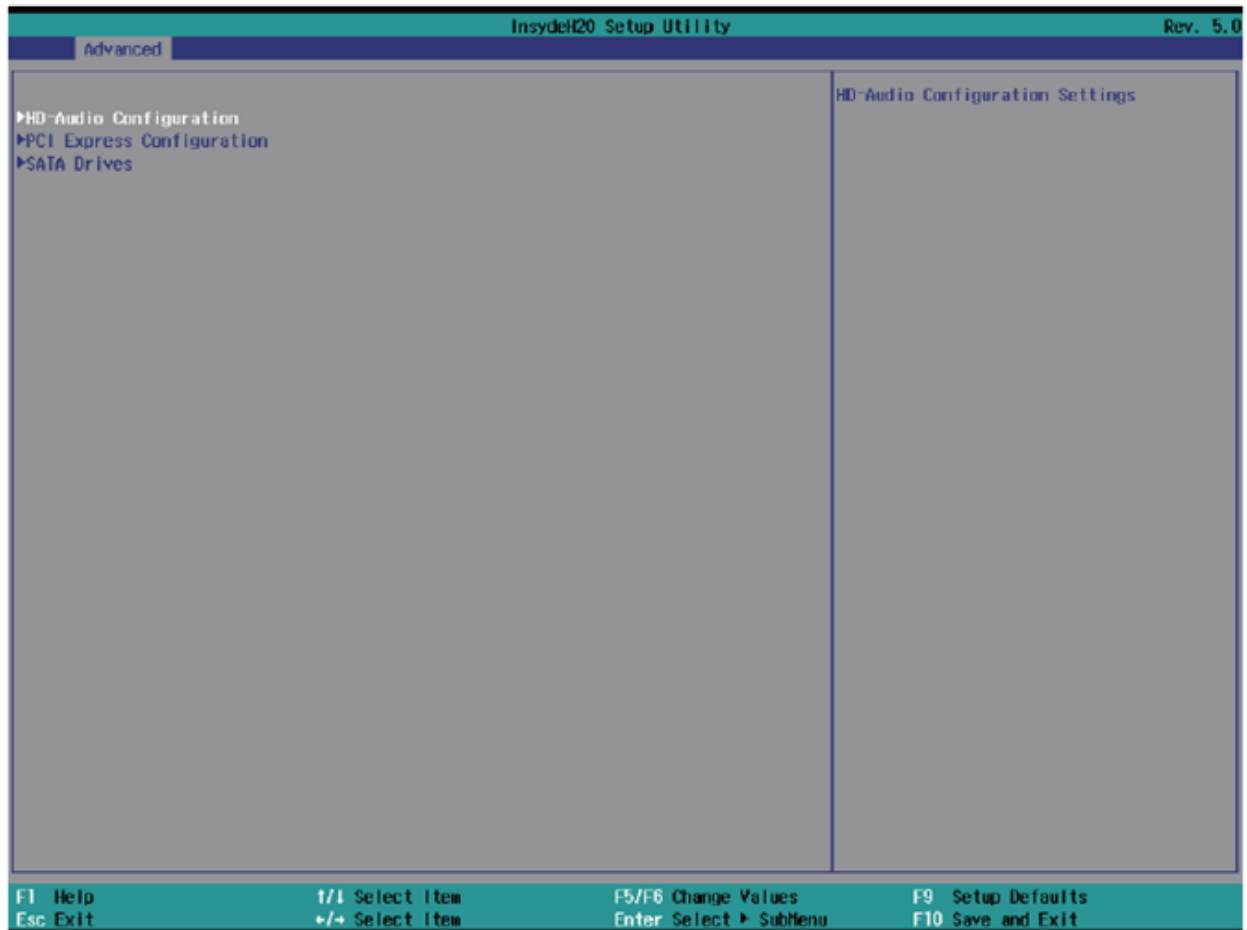

Control audio capabilities to suit your media needs:

- **HD-Audio Support:** Toggle the high-definition audio to enhance your multimedia experience. Available settings are Enabled (default) and Disabled, allowing you to optimize audio performance according to your needs.

## 10.6.3 PCI Express Configuration

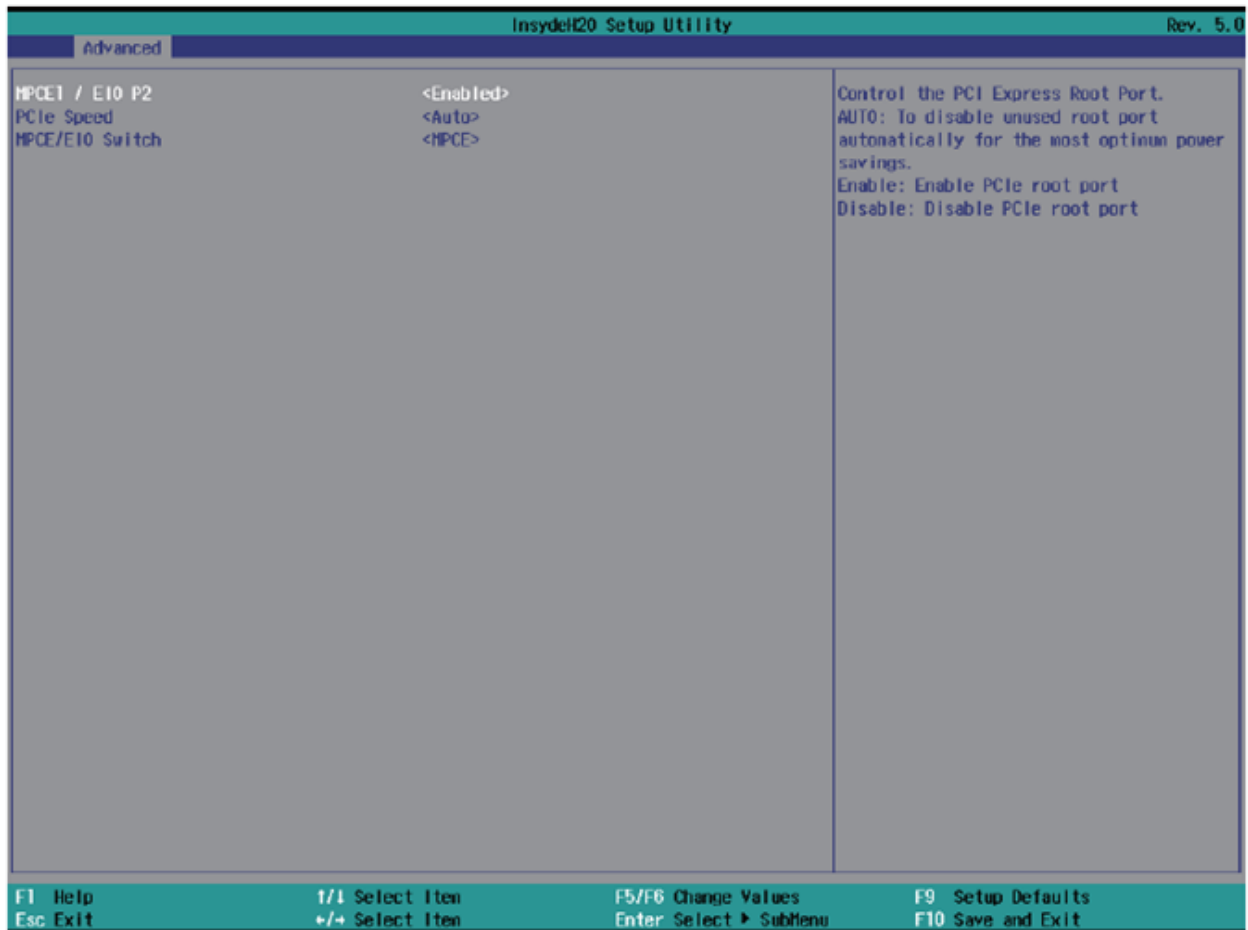

Configure the PCI Express settings to optimize connectivity and performance for expansion cards:

- **MPCE1 / EIO P2:** Enable or disable the MPCE1 slot with options for Disabled or Enabled (default), adapting to your hardware expansion needs.
- **PCIe speed:** Set the operational speed of the PCIe slots to match component specifications for optimal performance. Options include Auto (default), Gen1, and Gen2.
- **MPCE / EIO Switch:** Direct the PCIe signal either to the MPCE1 (default) or to the EIO, catering to different internal expansion needs for OEM I/O or function boards.

## 10.6.4 SATA Drives Configuration

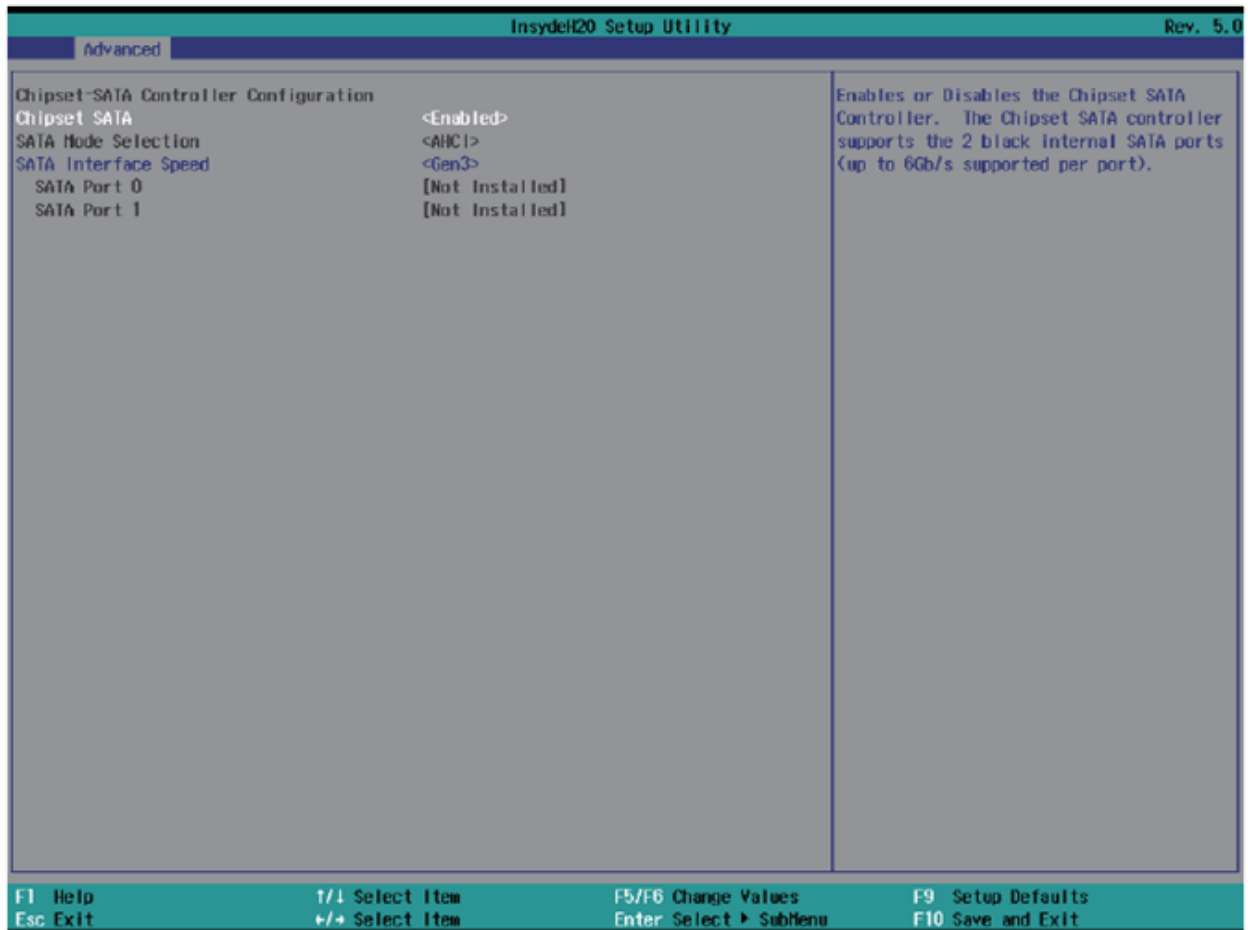

Manage SATA settings to control internal storage interfaces and improve drive performance:

- **Chipset SATA:** Toggle the SATA controller to enhance system compatibility and power management with options for Enabled (default) or Disabled.
- **SATA Mode Select:** Note that the Arrakis MK3 operates exclusively in AHCI mode, ensuring modern storage performance and features.
- **SATA Interface Speed:** Choose the operation speed of the SATA ports to match your drive capabilities for improved data transfer rates. Available speeds are Gen1, Gen2, and Gen3 (default).

## 10.6.5 Thermal Configuration

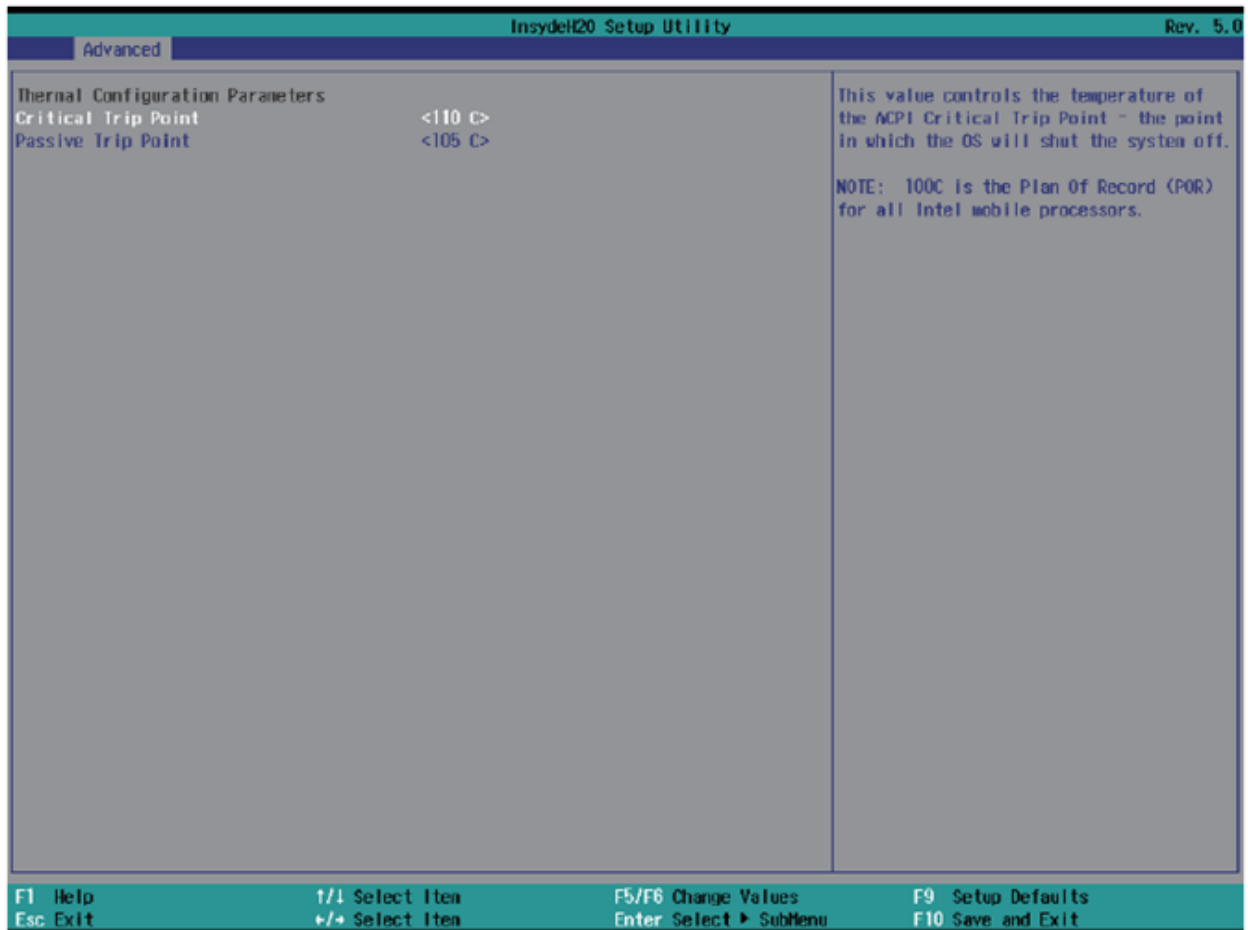

Adjust the system's thermal settings to optimize performance and prevent overheating:

- **Thermal Configuration Parameters:** Manage the system's temperature thresholds that determine at which temperatures the OS will take critical actions.
- **Critical Trip Point:** Set at a default of 110°C, this is the temperature at which the system will shut down to prevent damage.
- **Passive Trip Point:** Set at a default of 105°C, this is the temperature at which the system begins to throttle CPU frequency to reduce heat generation.

## 10.6.6 SIO FINETEK 81801U Configuration

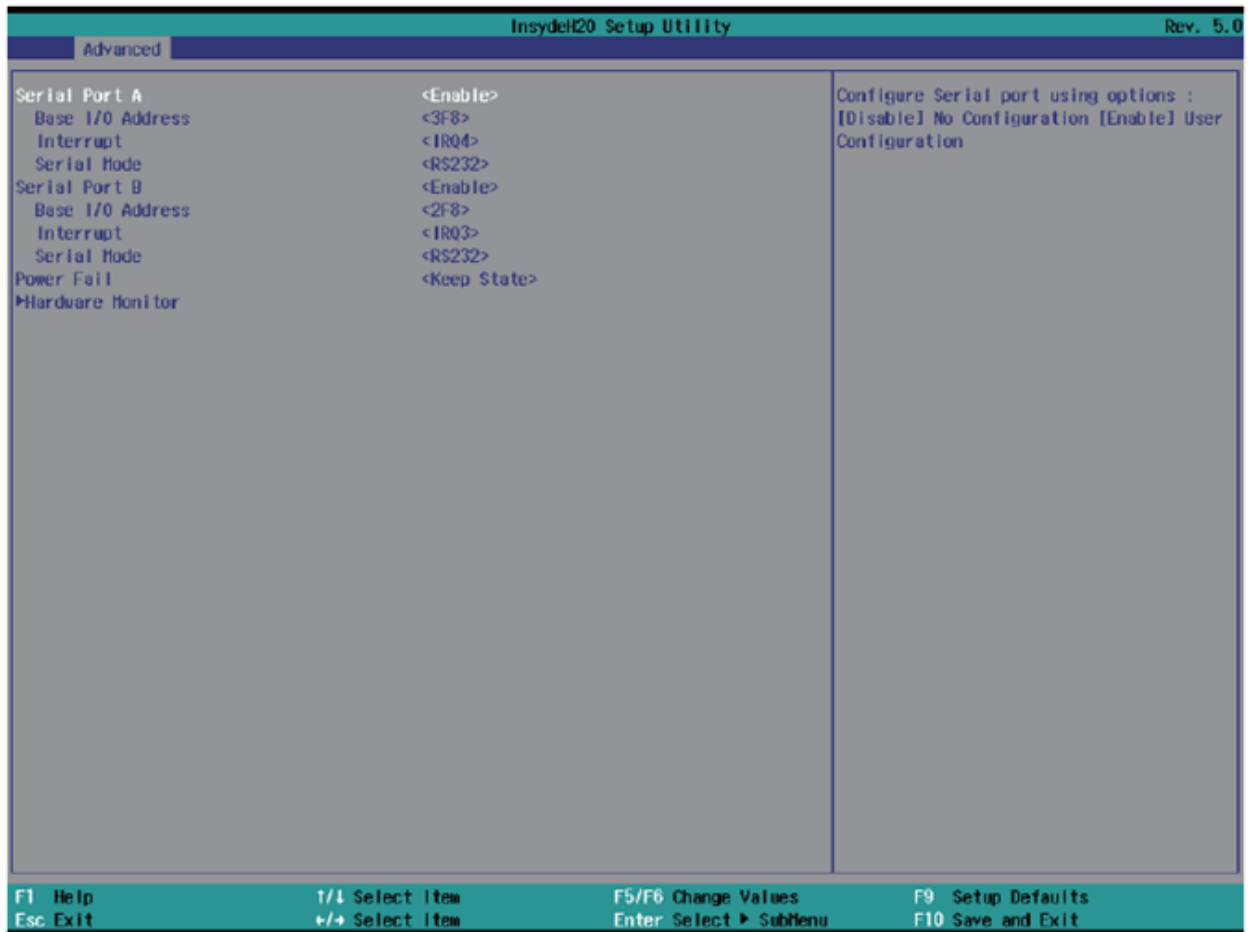

Configure serial port settings and power failure responses for system stability and expanded connectivity:

- **Serial Port A/B:** Enable or disable COM ports as required, with both ports enabled by default.
- **Base IO Address / Interrupt:** Customize the I/O addresses and interrupts for each serial port with options such as:
  - IO=3F8h; IRQ=4 for Port A (default)
  - IO=2F8h; IRQ=3 for Port B (default)
- **Serial Mode:** Select between RS232 (default) and RS485 modes, the latter includes auto flow control for RS485.
- **Power Failure Settings:**
  - **Keep state** (default): Maintains the system's last state in case of power disruption.
  - **Always on:** System reboots automatically after power restoration.
  - **Always off:** System stays off after power loss.
- **Hardware Monitor:** Monitors and displays crucial system voltage and temperature readings, providing real-time data to safeguard the system's operational health.

## 10.7 Security Settings

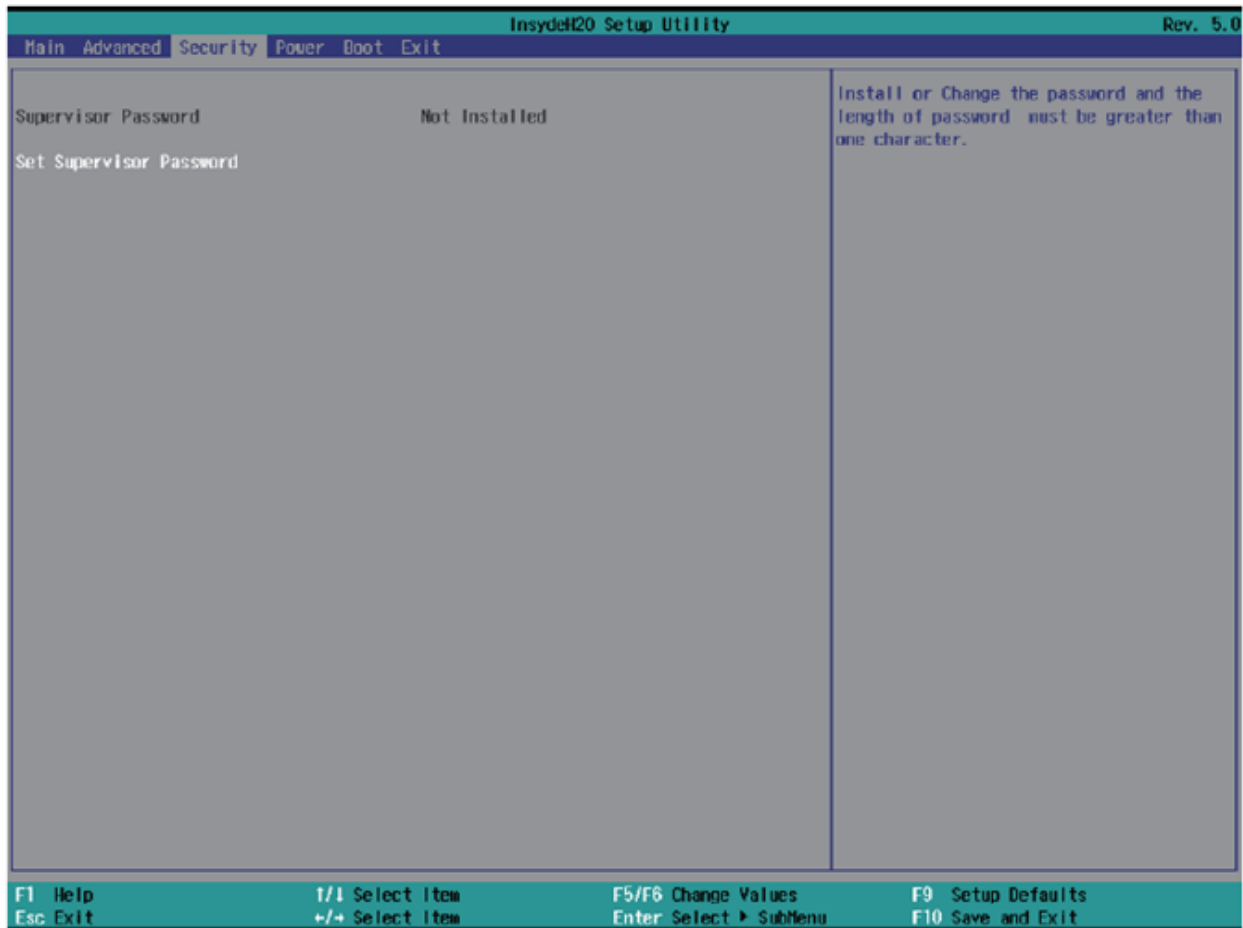

Set up a Supervisor password to enhance system security:

1. **Select Supervisor Password:** Opens a dialog to create a new password.
2. **Create Password:** Enter a password between 3 and 10 characters long.
3. **Confirm:** Press the `Enter` key to set the password.

## 10.8 Power Management

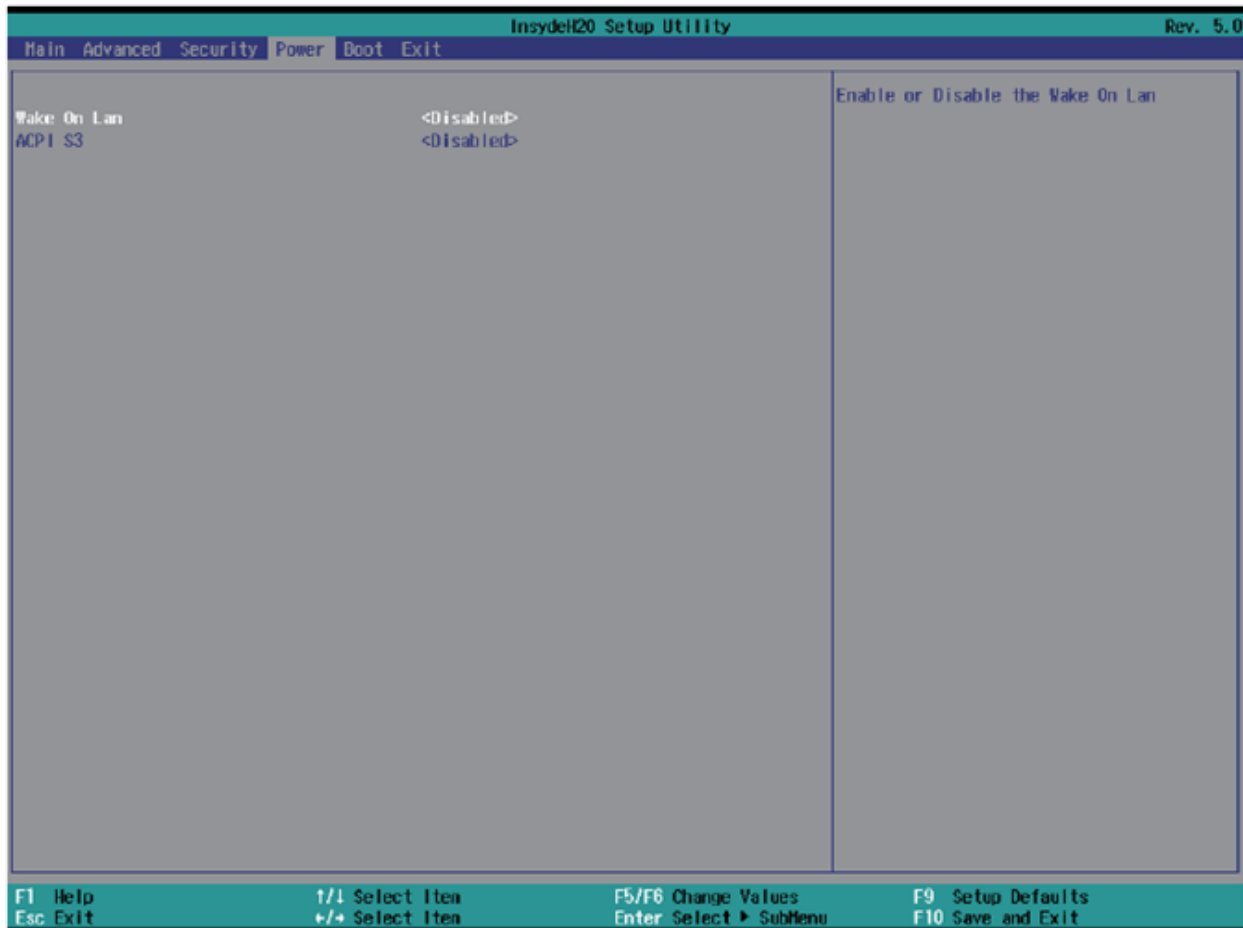

Configure settings to manage power and wake capabilities:

- **Wake on LAN:** Enable the system to wake from sleep states (S3 or S5) via LAN.
  - Options: S3, S5, S3 / S5, Disabled (default)
- **ACPI S3 Support:** Decide if the system should support the ACPI S3 sleep state for energy saving.
  - Options: Enabled, Disabled (default)

## 10.9 Boot Configuration

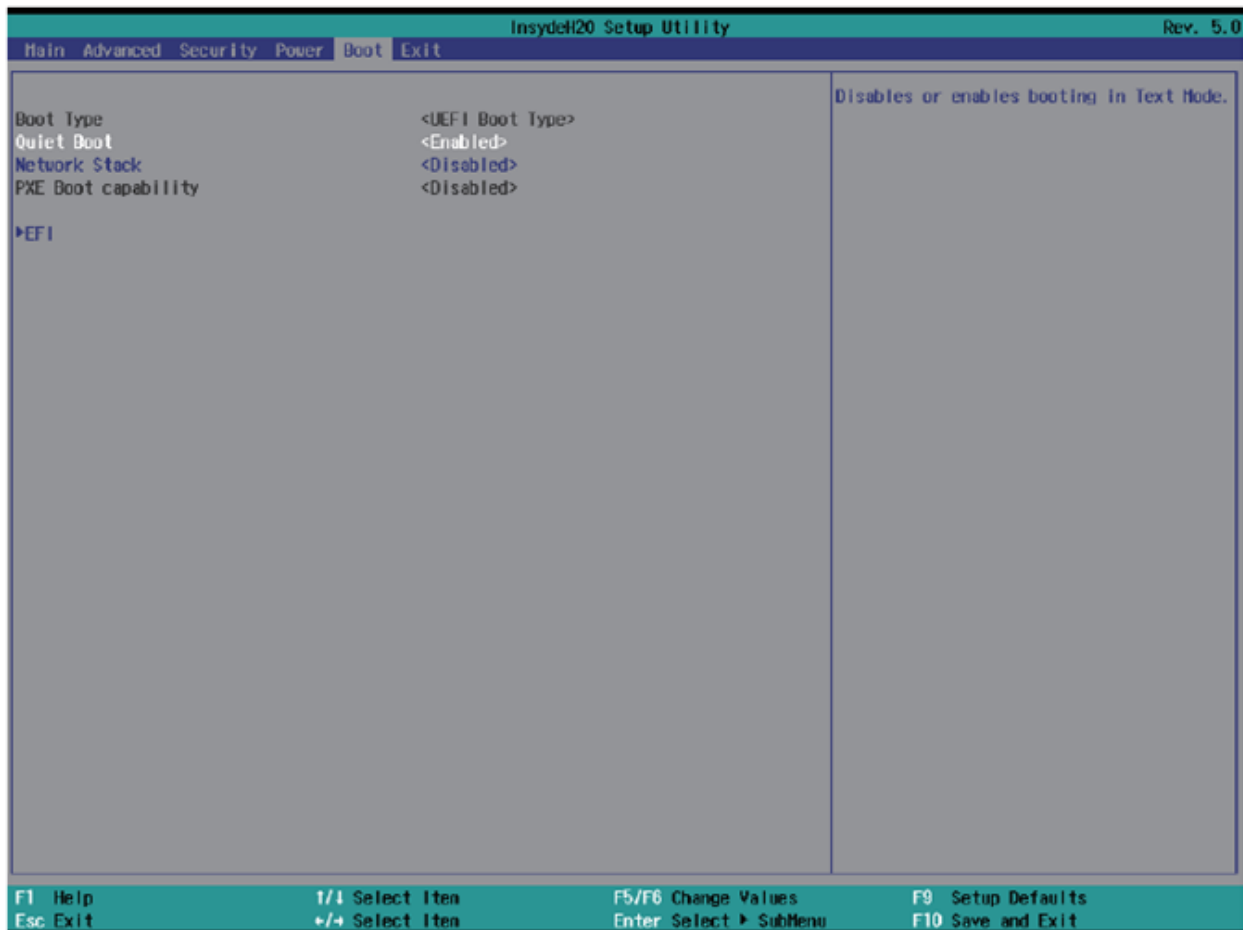

Manage settings that control the system's boot operations:

- **Boot Type:** Specifies that the Arrakis MK3 supports UEFI Boot only.
- **Quiet Boot:** Controls the display of messages during boot.
  - Options: Enabled (default), Disabled
- **Network Stack:** Enable this if using PXE functionality; otherwise, it should be disabled (default).
- **PXE Boot Capability:** Sets the protocol for PXE operations.
  - Options: Disabled (default), UEFI: IPv4, UEFI: IPv6
- **EFI Device Priority:** Determines which EFI-enabled storage device the system should boot from.



## 10.10 Exit Options

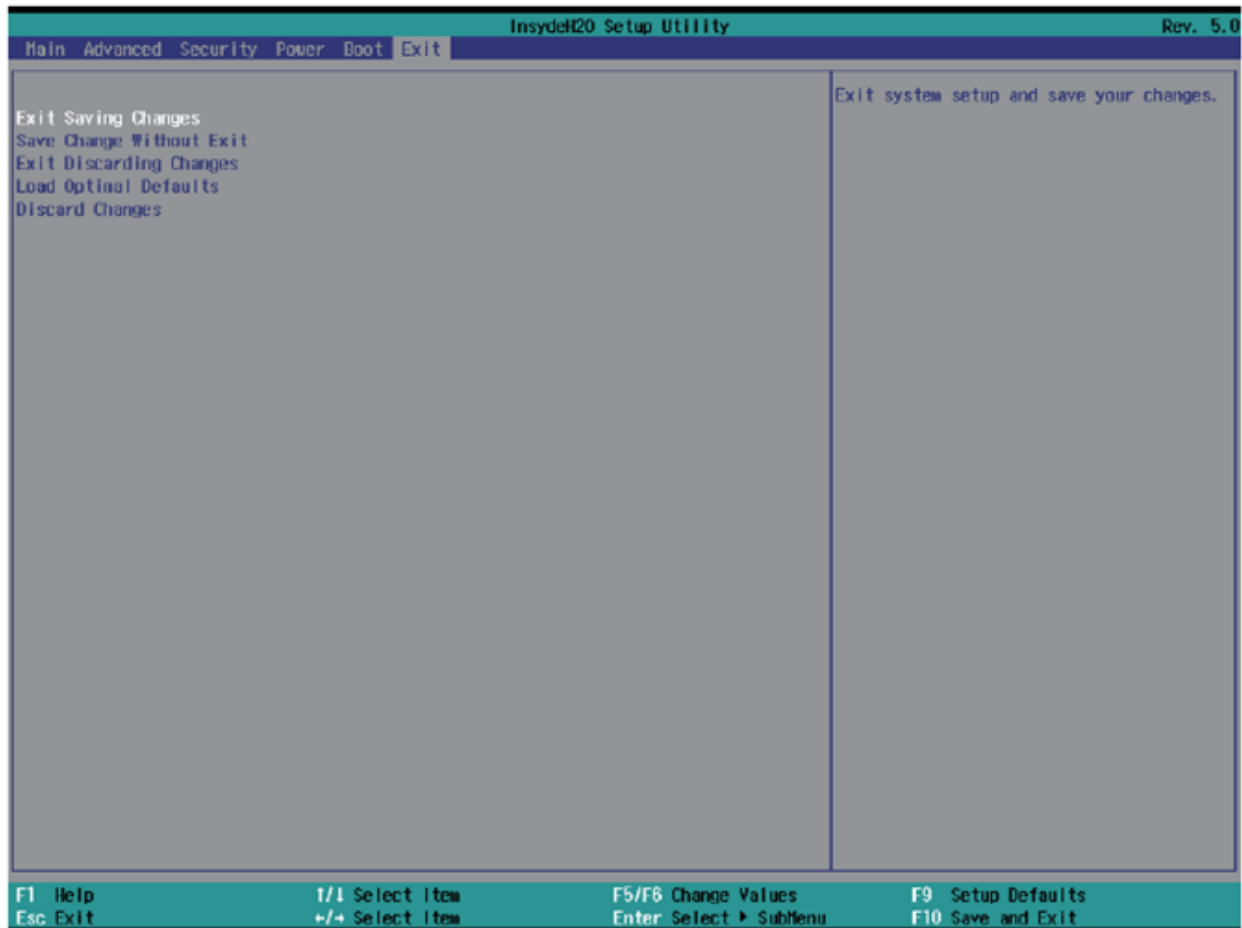

Manage your BIOS settings changes efficiently with these exit options:

- **Exit Saving Changes:** Saves all modifications and reboots the system, applying the new settings.
- **Save Changes Without Exit:** Saves your changes without rebooting, allowing you to continue adjusting settings.
- **Exit Discarding Changes:** Exits the BIOS without saving, reverting to previously saved settings, and reboots the system.
- **Load Optimal Defaults:** Resets the BIOS to the factory settings, which are optimized for general use.
- **Discard Changes:** Cancels any unsaved changes, reverting to the last saved configurations.

# 11 Driver Installation Guidance

The Arrakis MK3 typically comes with an Operating System preinstalled for optimal performance.

Should you need to install or reinstall the operating system or other software on the Arrakis MK3 without a pre-installed system, all necessary drivers are readily available for download. Simply scan the QR code provided or visit the link below to access the full range of system drivers:



[Download Drivers](#)

To install the drivers, follow the on-screen instructions provided by the driver installation programs. This ensures your system is up-to-date and functioning efficiently.

# 12 Appendix A: Power Consumption

This appendix outlines the power consumption metrics for the Arrakis MK3 system under various operating conditions. The specific hardware configurations and operating parameters used during testing are listed below. These results should be considered as a reference only, as actual power consumption can vary based on software and hardware options.

### Hardware Configuration:

- **CPU:** Intel Atom E3950
- **Memory:** 4GB DDR3L at 1866MHz
- **Operating System:** Windows 10 IoT 2019 LTSC
- **Storage:** 64GB mSATA
- **Benchmarking Tool:** Passmark

### Power Consumption Measurements:

Voltage	Power Off	Startup (Max)	Startup (Stable)	Burn-in (Max)	Shutdown
12V	0.14A	0.95A	0.62A	1.10A	0.82A
24V	0.09A	0.50A	0.32A	0.57A	0.42A

**Note:** Power consumption values depend significantly on the configuration and usage of the system.

# 13 Appendix B: F75111N DIO & Watchdog Device

The Arrakis MK3, equipped with optional DIO ports, supports enhanced functionality through the use of a watchdog timer. This section provides guidance on how to program and utilize these features effectively.

## 13.1 Watchdog Timer Usage in DOS

The necessary software resources for programming the watchdog timer can be accessed from the Driver Download section:

- **Source File:** F75111\_Dos\_Src.rar
- **Binary File:** F75111\_Dos\_Bin.rar
- **Access Credentials:** Username & Password: sf

### 13.1.1 Steps to Utilize the Demo Application:

1. Boot into the MS-DOS operating system.
2. Run the 75WDT.EXE executable file.
3. Enter 1 to activate the watchdog timer, or 0 to deactivate it.
4. Specify the countdown duration in seconds for the timer, which will subsequently reset the computer.

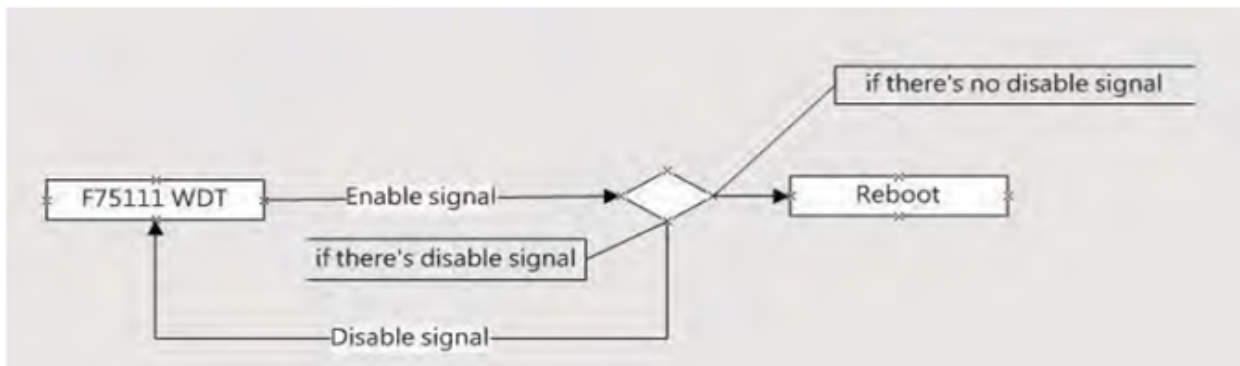

### 13.1.2 Programming Example:

Below are examples of how to interact with the watchdog timer using I2C communication:

- **Activate and set the watchdog timer:**

```
WriteI2CByte(I2CADDR, CONFIG, 0x03); // Configure watchdog timer function
WriteI2CByte(I2CADDR, WDT_TIMER, timer); // Set timer range 0-255 seconds
WriteI2CByte(I2CADDR, WDT_TIMER_CTL, 0x73); // Enable timer in second and pulse mode
```

- **Deactivate the watchdog timer:**

```
WriteI2CByte(I2CADDR, WDT_TIMER_CTL, 0x00); // Disable watchdog timer
```

- **Sample code to pause operation using assembly language:**

```
void pause(int time) {
    asm mov ah, 0h; // Set to read system time counter
    asm int 1ah;    // Read time from counter, store in DX
    asm add dx, time;
    asm mov bx, dx;
label:
    asm int 1ah;
    asm cmp bx, dx;
    asm jne label;
}
```

## 13.2 Watchdog Timer and DIO Configuration

You can find the necessary software resources in the Driver Download section under the DIO folder:

- **Source File:** F75111\_DIOSrc.rar
- **Binary File:** F75111\_DemoBin.rar
- **Access Credentials:** Username & Password: sf

## 13.2.1 Using the Demo Application

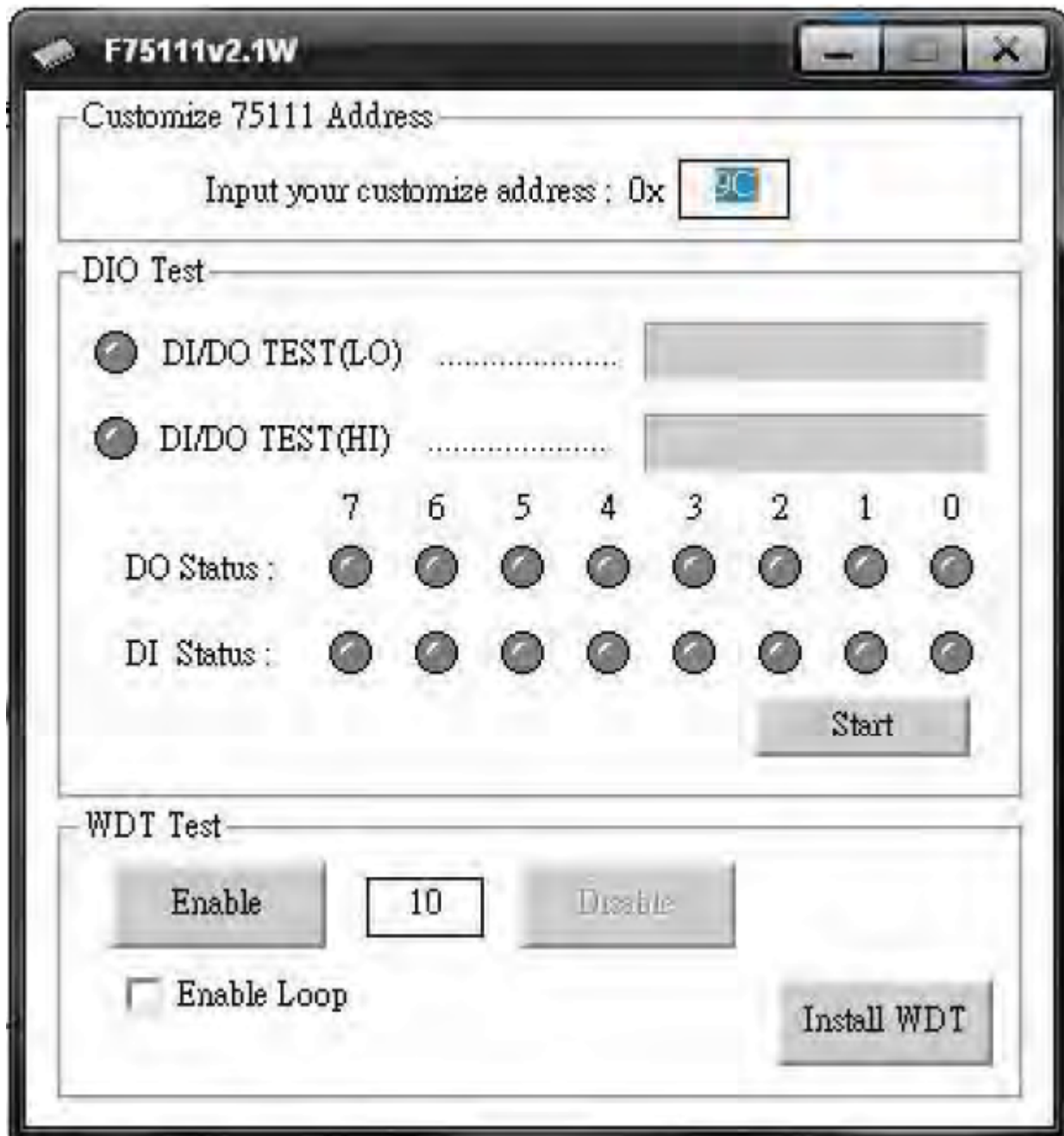

To test and configure the DIO and Watchdog Timer functions, follow these steps:

1. Click the **Start** button to begin testing the DIO functionality.
2. Click the **Enable** button to activate the Watchdog Timer (WDT).
3. Click the **Disable** button to deactivate the WDT.
4. To conduct a loop test, check the **Enable Loop** box and press **Enable**.
5. Use the **Install WDT** button to configure the system to auto-run this application at boot. Click again to remove the auto-run setting. An icon indicates when this setting is active.

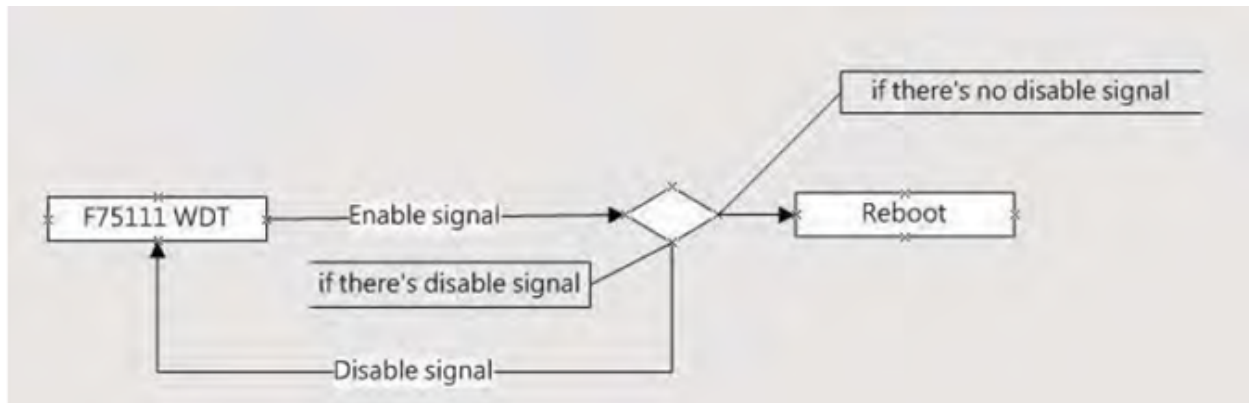

## 13.2.2 Command Functions

- **Watchdog Timer Initialization:** Configure the initial internal F75111 port settings and enable necessary functions.
- **Digital Output (DO):** Set digital output values.
- **Digital Input (DI):** Retrieve digital input values.
- **Watchdog Timer Enable/Disable:** Activate or deactivate the Watchdog Timer.

### Examples of Code Implementation:

#### 1. Initialize Watchdog Timer and Ports:

```
// Initialize F75111 internal settings for input and output configurations
InitInternalF75111();
```

#### 2. Set Output Values:

```
// Output a specific byte value to digital output
InterDigitalOutput(byteValue);
```

#### 3. Retrieve Input Values:

```
// Get input values from digital input
BYTE inputStatus = InterDigitalInput();
```

#### 4. Manage Watchdog Timer:

```
// Enable the Watchdog Timer with a specific timeout
F75111_SetWDTEnable(timerValue);
// Disable the Watchdog Timer
F75111_SetWDTDisable();
```

## 13.3 IO Device: F75111 VB6 under Windows

You can find the necessary software resources in the Driver Download section under the DIO folder:

- **Source File:** 75111\_VB\_v10.rar
- **Binary File:** 75111\_VB\_Src.rar111\_DemoBin.rar
- **Access Credentials:** Username & Password: sf

### 13.3.1 How to Use the Demo Application

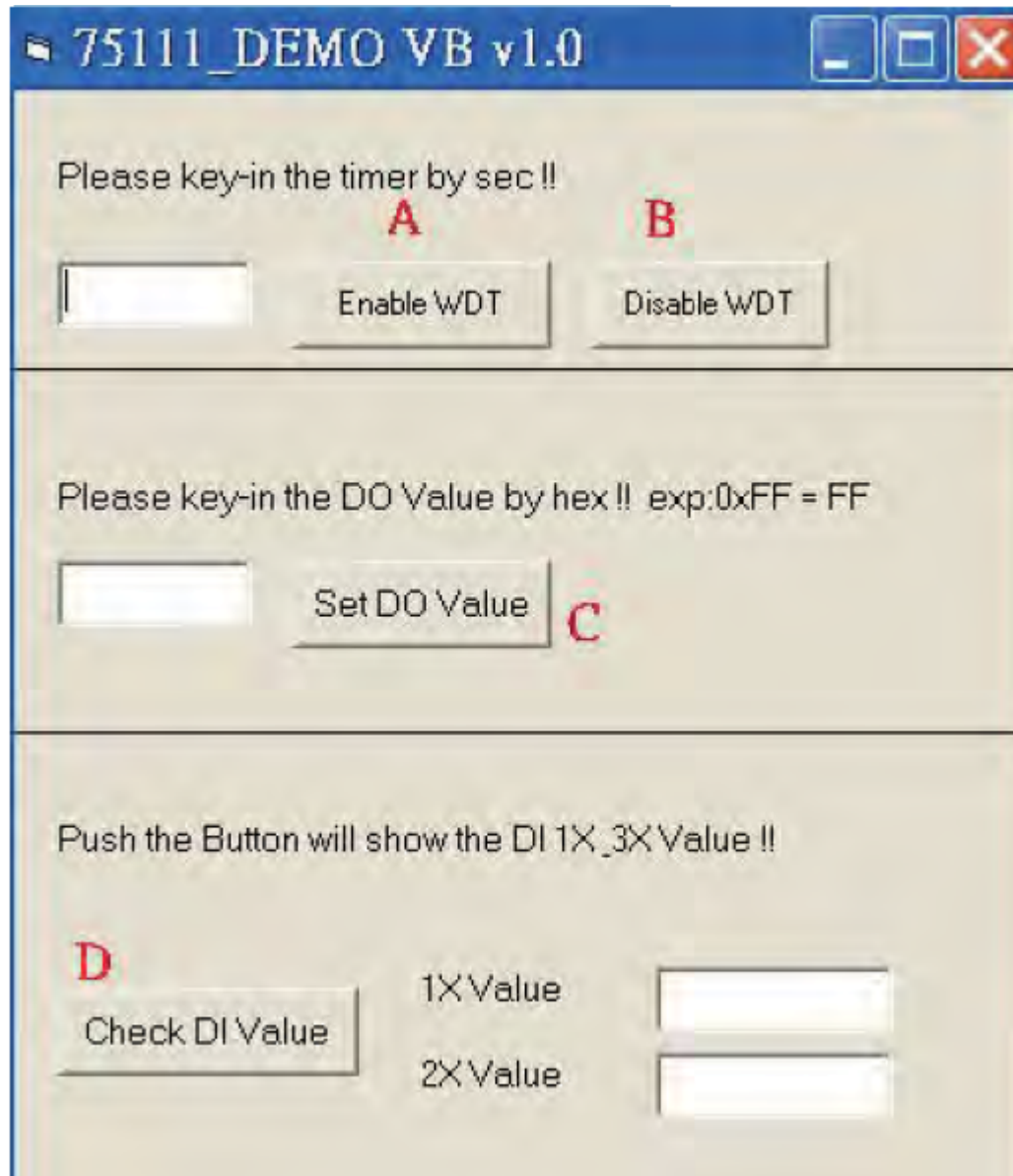

**A. Enable WDT Timer:** Enter the desired time in seconds, then the system will reboot after the specified time. **B. Disable WDT Timer:** Press the button to clear the WDT timer value. **C. Set DO Value:** Enter the DO value in hexadecimal and press the button. **D. Check DI Value:** The right-side text boxes display the DI 1X & 2X values when the button is pressed.

### 13.3.2 SDK Function Introduction

**Function EnableWDT:**

```
Function EnableWDT(timer As Integer)
    Call WriteI2CByte(&H3, &H3)
    Call WriteI2CByte(&H37, timer)
    Call WriteI2CByte(&H36, &H73)
End Function
```

**Function DisableWDT:**



```
Function DisableWDT()  
    Call WriteI2CByte(&H36, &H0)  
End Function
```

#### Function SetDOValue:

```
Function SetDOValue(dovalue As Integer)  
    Call WriteI2CByte(&H23, &H0)  
    Call WriteI2CByte(&H20, &HFF)  
    Call WriteI2CByte(&H2B, &HFF)  
    Call WriteI2CByte(&H21, dovalue)  
End Function
```

#### Function CheckDIValue:

```
Function CheckDIValue()  
    Dim GPIO1X As Integer  
    Dim GPIO3X As Integer  
    Dim DI1Xhex As String  
    Dim DI3Xhex As String  
  
    Call ReadI2CByte(&H12, GPIO1X)  
    Call ReadI2CByte(&H42, GPIO3X)  
  
    DI1Xhex = Hex(GPIO1X)  
    DI3Xhex = Hex(GPIO3X)  
  
    Text3.Text = "0x" + DI1Xhex  
    Text4.Text = "0x" + DI3Xhex  
End Function
```

## 13.4 Watchdog Timer and DIO under Linux

You can find the necessary software resources in the Driver Download section under the DIO folder:

- **Source File:** F75111v2.0L.tar.gz
- **Binary File:** F75111v2.0LBin.tar.gz
- **Access Credentials:** Username & Password: sf

### 13.4.1 How to Compile Source Code

#### 1. Compile Source Code with Code::Blocks

- Install Code::Blocks with the command: `apt-get install codeblocks`
- Open the existing project (F75111.cbp) in Code::Blocks and click the compile button
- Add the option `'pkg-config --libs gtk+-2.0 gthread-2.0'` in `Project->Build Options->Linker Settings->Other linker options`

#### 2. Compile Source Code with make

- Navigate to the F75111 directory: `cd F75111`
- Compile the source code: `make`
- Execute the binary file: `src/f75111`

## 13.4.2 How to Use the Demo Application



1. Press the **Start** button to test the DIO function
2. Press the **Enable** button to test the WDT function
3. Press the **Disable** button to disable the WDT
4. Check the **Enable Loop** box and press **Enable** to perform a WDT loop test
5. Press **Install** to set the system to autorun this application when booting, and press **Uninstall** to remove it from autorun
6. If WDT is enabled, the system icon will blink

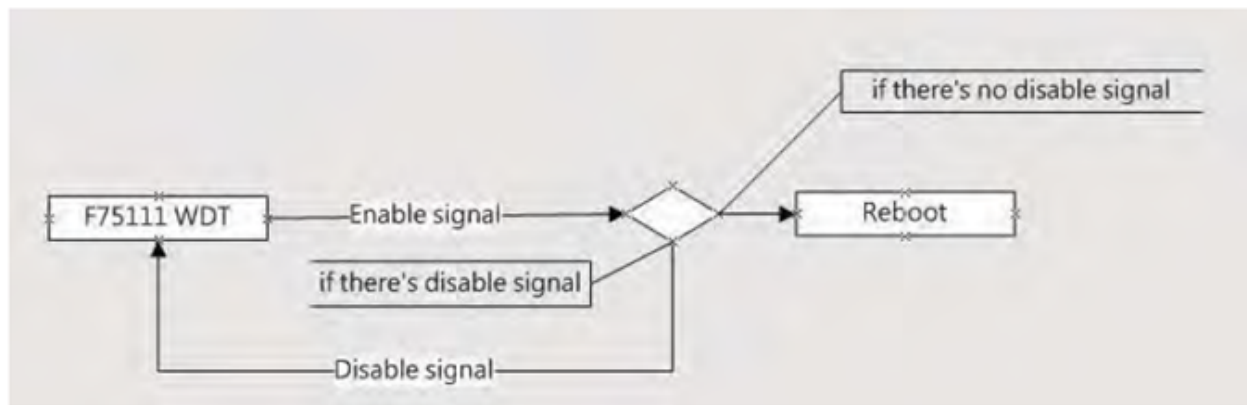

F75111 will send `F75111_SetWDTEnable(BYTE byteTimer)` with a parameter `timer`. If there is no disable signal (`F75111_SetWDTDisable()`) before the timer counts down to 0, the system will reboot. If a disable signal is received, it will resend the enable WDT signal to prevent a reboot loop.

## 13.4.3 Introduction

IO Function in `SMBus.c`:

```
void SMBusIoWrite(BYTE byteOffset, BYTE byteData) {
    outb(byteData, m_SMBusMapIoAddr + byteOffset);
}

BYTE SMBusIoRead(BYTE byteOffset) {
    DWORD dwAddrVal;
    dwAddrVal = inb(m_SMBusMapIoAddr + byteOffset);
    return (BYTE)(dwAddrVal & 0xFF);
}
```

Initialize Internal F75111:

```
void F75111::InitInternalF75111() {
    this->Write_Byte(F75111_INTERNAL_ADDR, GPIO1X_CONTROL_MODE, 0x00); // Set GPIO1X to Input
    ↪function
    this->Write_Byte(F75111_INTERNAL_ADDR, GPIO3X_CONTROL_MODE, 0x00); // Set GPIO3X to Input
    ↪function
    this->Write_Byte(F75111_INTERNAL_ADDR, GPIO2X_CONTROL_MODE, 0xFF); // Set GPIO2X to Output
    ↪function
    this->Write_Byte(F75111_INTERNAL_ADDR, F75111_CONFIGURATION, 0x03); // Enable WDT OUT function
}
```

Set Output Value:

```
void F75111::InterDigitalOutput(BYTE byteValue) {
    BYTE byteData = 0;
    byteData = (byteData & 0x01) ? byteValue + 0x01 : byteValue;
    byteData = (byteData & 0x02) ? byteValue + 0x02 : byteValue;
    byteData = (byteData & 0x04) ? byteValue + 0x04 : byteValue;
    byteData = (byteData & 0x80) ? byteValue + 0x08 : byteValue;
    byteData = (byteData & 0x40) ? byteValue + 0x10 : byteValue;
    byteData = (byteData & 0x20) ? byteValue + 0x20 : byteValue;
    byteData = (byteData & 0x10) ? byteValue + 0x40 : byteValue;
    byteData = (byteData & 0x08) ? byteValue + 0x80 : byteValue; // Get value bit by bit
    this->Write_Byte(F75111_INTERNAL_ADDR, GPIO2X_OUTPUT_DATA, byteData); // Write byteData value
    ↪via GPIO2X output pin
}
```

### Get Input Value:

```
BYTE F75111::InterDigitalInput() {
    BYTE byteGPIO1X = 0;
    BYTE byteGPIO3X = 0;
    BYTE byteData = 0;
    this->Read_Byte(F75111_INTERNAL_ADDR, GPIO1X_INPUT_DATA, &byteGPIO1X); // Get value from GPIO1X
    this->Read_Byte(F75111_INTERNAL_ADDR, GPIO3X_INPUT_DATA, &byteGPIO3X); // Get value from GPIO3X
    byteGPIO1X = byteGPIO1X & 0xF0; // Mask unuseful value
    byteGPIO3X = byteGPIO3X & 0x0F; // Mask unuseful value
    byteData = (byteGPIO1X & 0x10) ? byteData + 0x01 : byteData;
    byteData = (byteGPIO1X & 0x80) ? byteData + 0x02 : byteData;
    byteData = (byteGPIO1X & 0x40) ? byteData + 0x04 : byteData;
    byteData = (byteGPIO3X & 0x01) ? byteData + 0x08 : byteData;
    byteData = (byteGPIO3X & 0x02) ? byteData + 0x10 : byteData;
    byteData = (byteGPIO3X & 0x04) ? byteData + 0x20 : byteData;
    byteData = (byteGPIO3X & 0x08) ? byteData + 0x40 : byteData;
    byteData = (byteGPIO1X & 0x20) ? byteData + 0x80 : byteData; // Get correct DI value from
↪ GPIO1X & GPIO3X
    return byteData;
}
```

### Enable WatchDog:

```
void F75111_SetWDTEnable(BYTE byteTimer) {
    WriteByte(F75111_INTERNAL_ADDR, WDT_TIMER_RANGE, byteTimer); // Set WatchDog range and timer
    WriteByte(F75111_INTERNAL_ADDR, WDT_CONFIGURATION, WDT_TIMEOUT_FLAG | WDT_ENABLE | WDT_PULSE |
↪ WDT_PSWIDTH_100MS);
    // Enable WatchDog, Setting WatchDog configure
}
```

### Disable WatchDog:

```
void F75111_SetWDTDisable() {
    WriteByte(F75111_INTERNAL_ADDR, WDT_CONFIGURATION, 0x00); // Disable WatchDog
}
```